



Leaderway VERTICAL MACHINING CENTER
(BOX WAY)

VERTICAL MACHINING CENTER

ELECTRICAL MANUAL

MITSUBISHI M70

MV1100S 、 MV1100D 、 MV1300S 、 MV1300D

LEADERWAY CNC TECHNOLOGIES CO., LTD.

NO. 36, Ln. 211, Taiming Rd.,
Wuri Dist, TAICHUNG 41468, TAIWAN

TEL: +886-4-2335-0711
FAX: +886-4-2335-0986

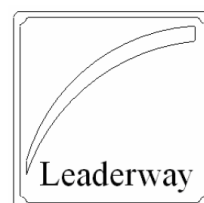

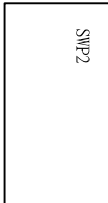
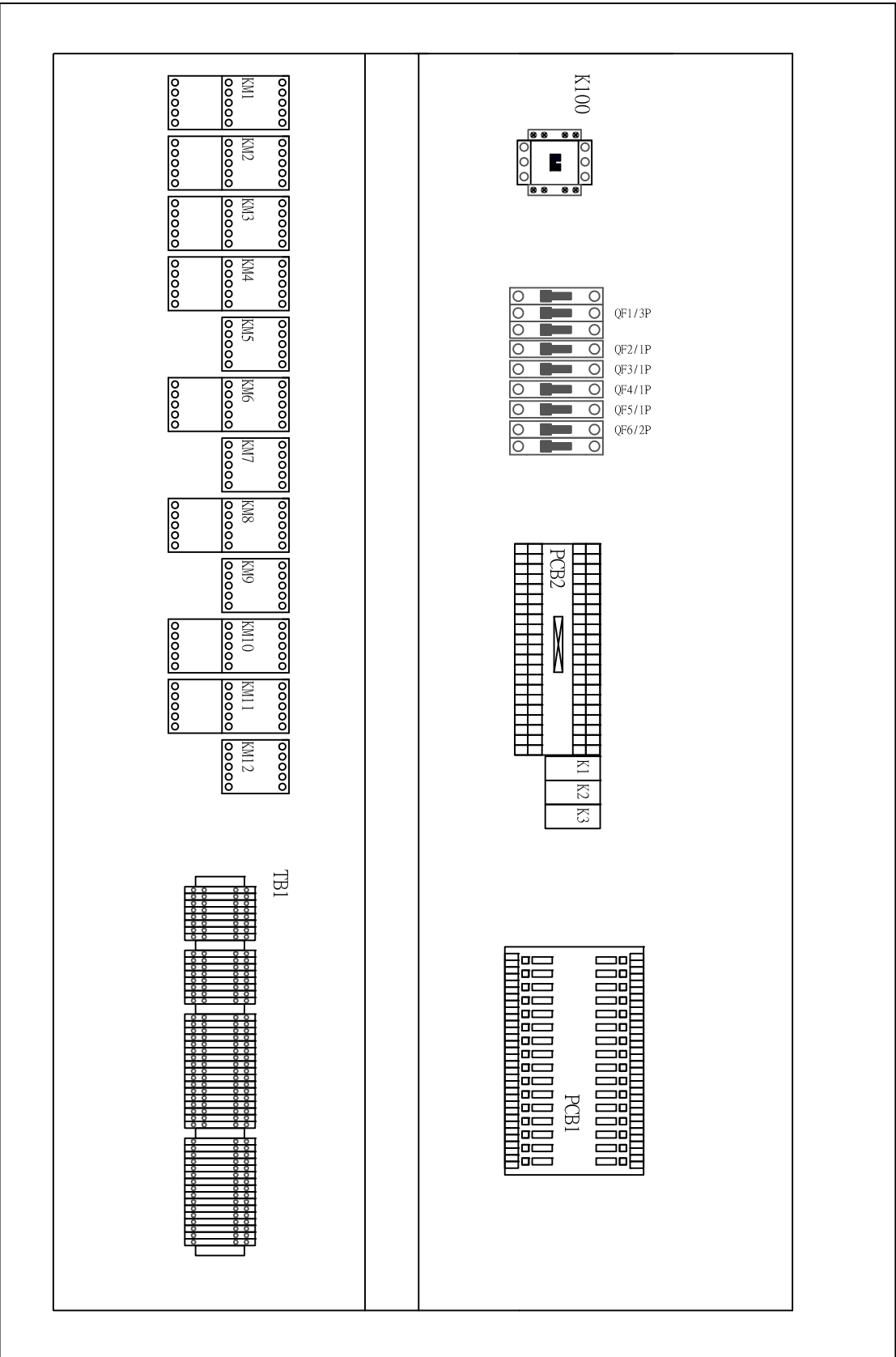

TITLE: ELECTRICAL CABINET BOARD LAYOUT
 (EXTEND 1/0) - V650



DESIGNER	CONTROL	MACHINE	PAGE	VER
2014/02/14	MITSUBISHI		0000	A

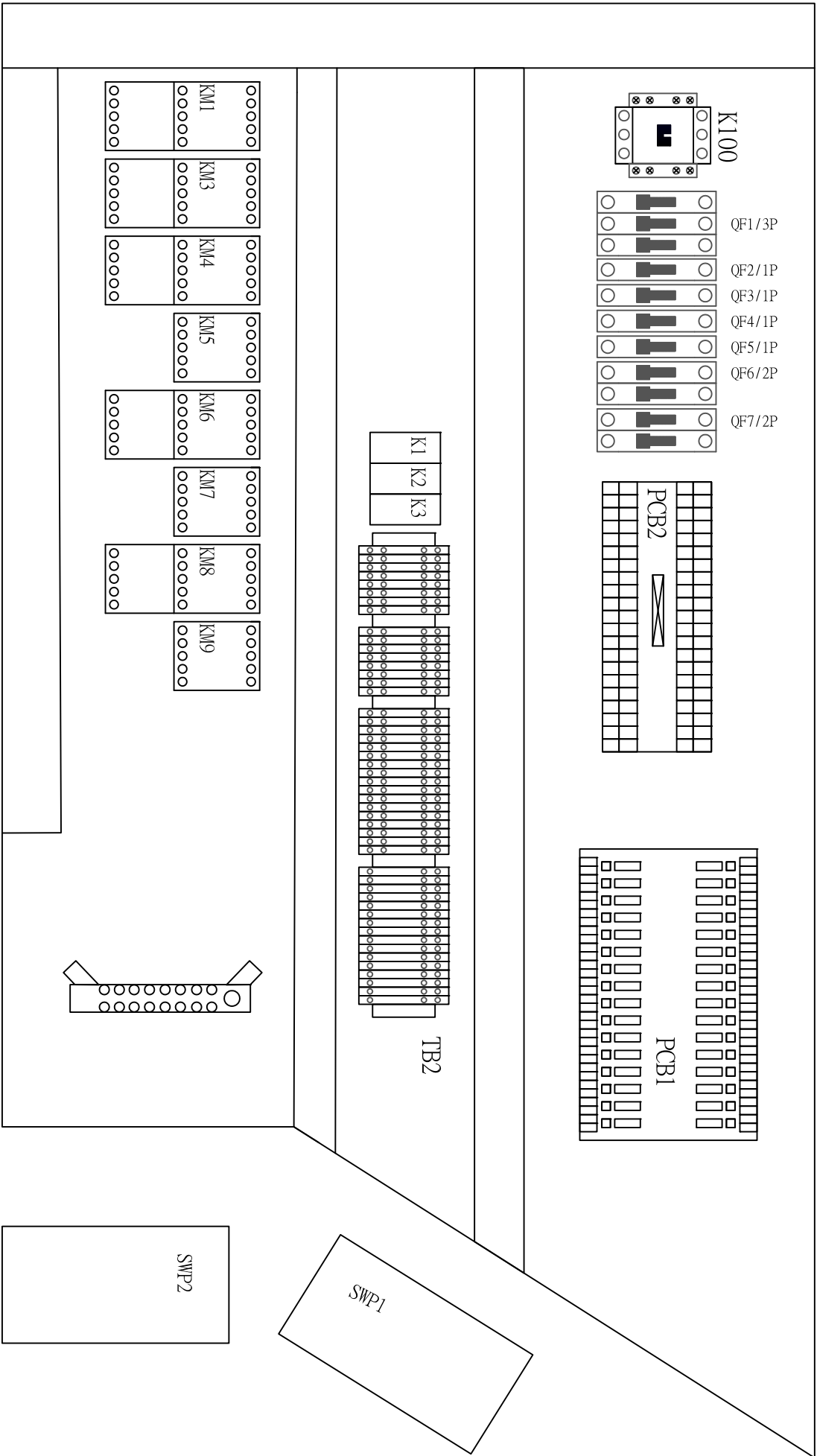

TITLE: ELECTRICAL CABINET BOARD LAYOUT
 (EXTEND I/O) - V331/V421

LEADERWAY

DESIGNER	CONTROL	MACHINE	PAGE	VER
2014/02/14	MTSUBISHI		0001	A

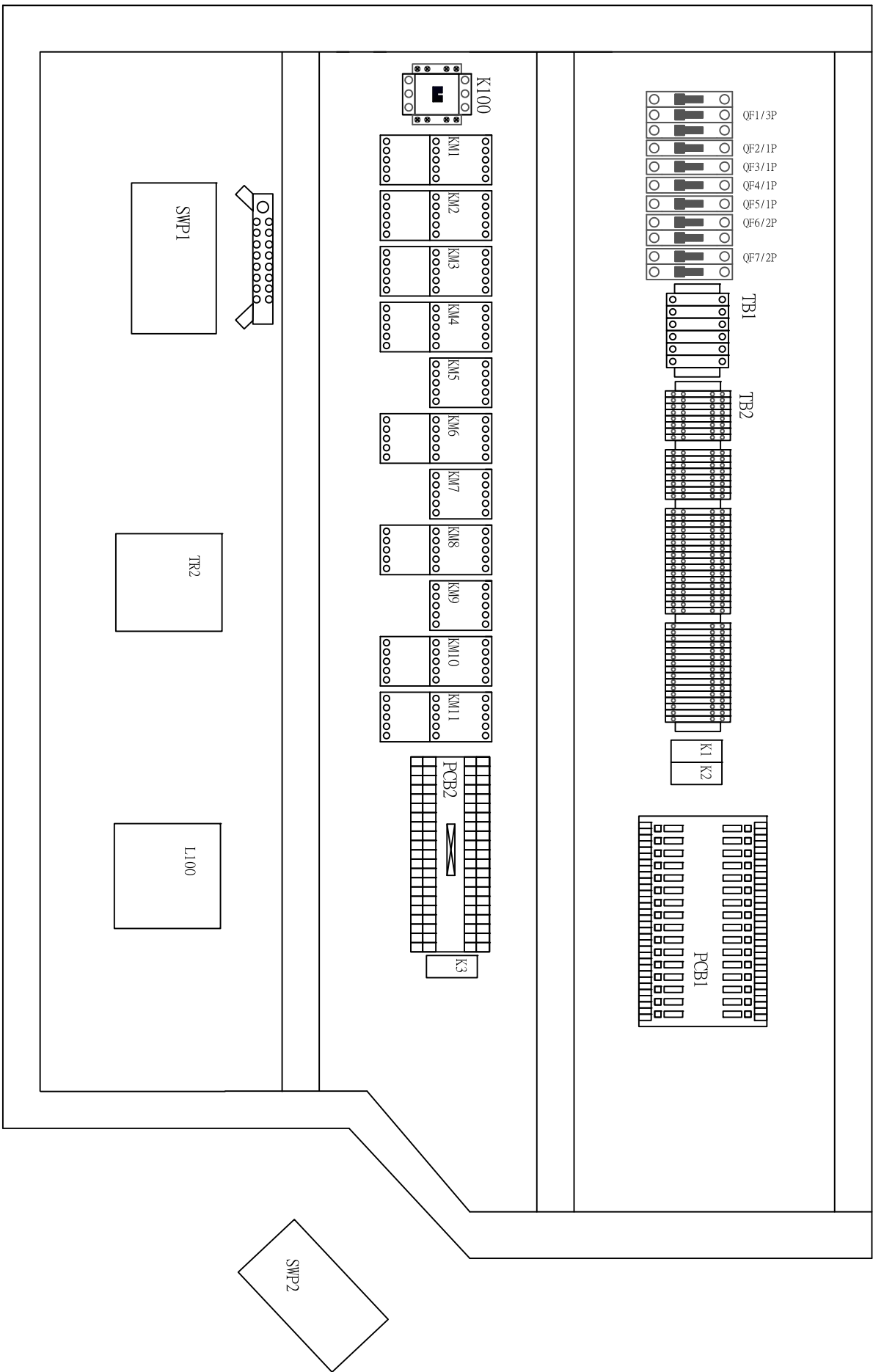

TITLE: ELECTRICAL CABINET BOARD LAYOUT
 (EXTEND I/O) - V1100/V1300

LEADERWAY

DESIGNER	CONTROL	MACHINE	PAGE	VER
2014/02/14	MITSUBISHI		0002	A

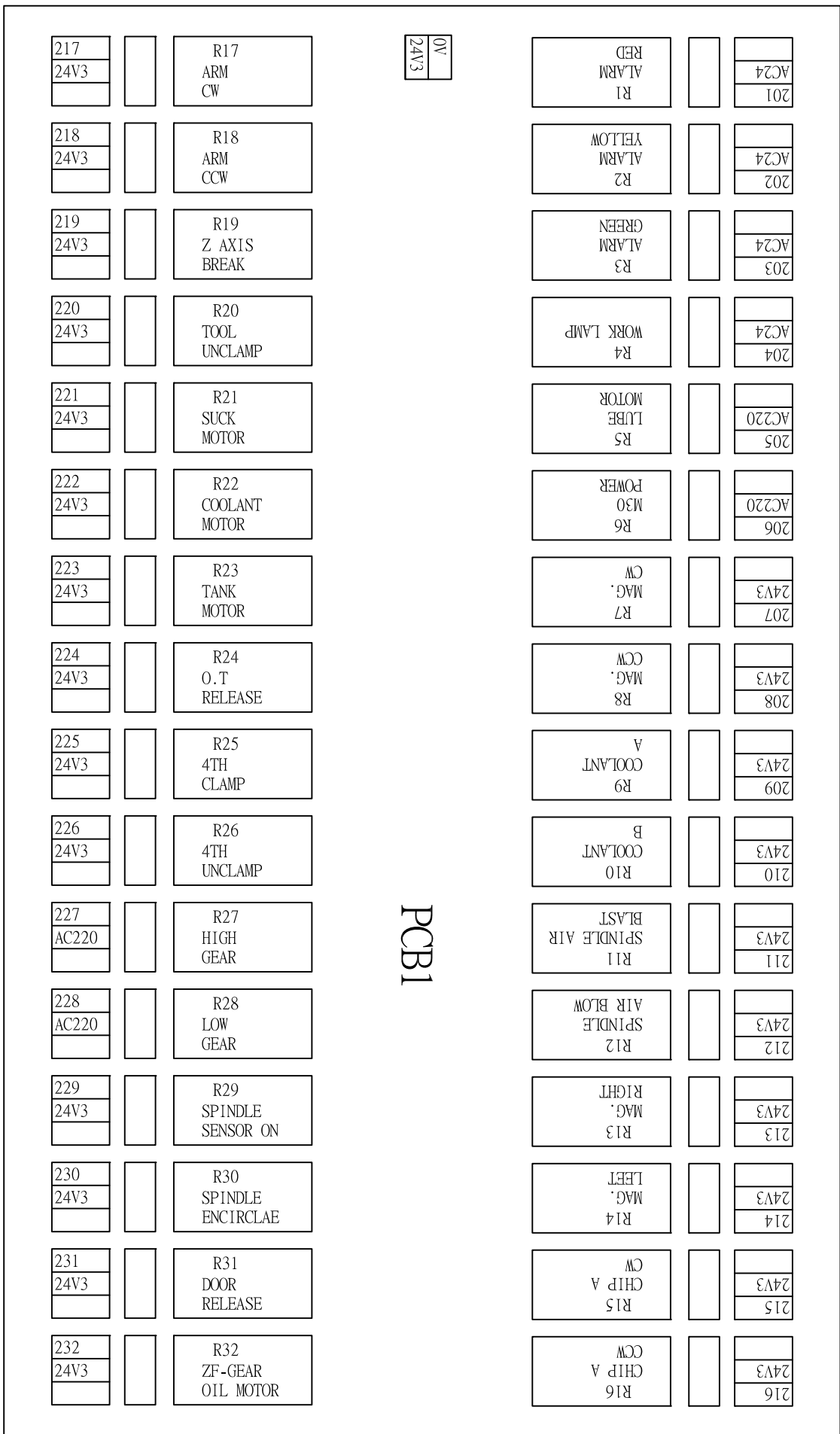

TITLE: LDW RLY32

LEADERWAY

DESIGNER

2014/02/14

CONTROL

MITSUBISHI

MACHINE

PAGE

0003

VER

A

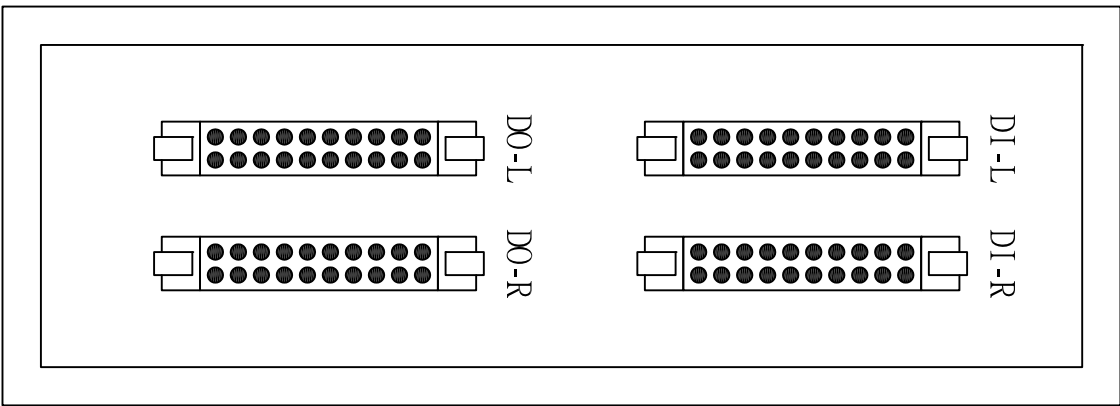

DI-L

1	2	3	4	5	6	7	8	9	10	11	12	13	14	15	16	17	18	19	20
0V	24V1	0V	24V1	0V	0V	0V		X1F	XF	X1E	XE	X1D	XD	X1C	XC	X1B	XB	X1A	XA
21	22	23	24	25	26	27	28	29	30	31	32	33	34	35	36	37	38	39	40
X19	X9	X18	X8	X17	X7	X16	X6	X15	X5	X14	X4	X13	X3	X12	X2	X11	X1	X10	X0

DI-R

1	2	3	4	5	6	7	8	9	10	11	12	13	14	15	16	17	18	19	20
0V	24V1	0V	24V1	0V	0V			X3F	X2F	X3E	X2E	X3D	X2D	X3C	X2C	X3B	X2B	X3A	X2A
21	22	23	24	25	26	27	28	29	30	31	32	33	34	35	36	37	38	39	40
X39	X29	X38	X28	X37	X27	X36	X26	X35	X25	X34	X24	X33	X23	X32	X22	X31	X21	X30	X20

DO-L

1	2	3	4	5	6	7	8	9	10	11	12	13	14	15	16	17	18	19	20
0V	24V1	0V	24V1					Y1F	YF	Y1E	YE	Y1D	YD	Y1C	YC	Y1B	YB	Y1A	YA
21	22	23	24	25	26	27	28	29	30	31	32	33	34	35	36	37	38	39	40
Y19	Y9	Y18	Y8	Y17	Y7	Y16	Y6	Y15	Y5	Y14	Y4	Y13	Y3	Y12	Y2	Y11	Y1	Y10	Y0

DO-R

1	2	3	4	5	6	7	8	9	10	11	12	13	14	15	16	17	18	19	20
0V	24V1	0V	24V1					Y3F	Y2F	Y3E	Y2E	Y3D	Y2D	Y3C	Y2C	Y3B	Y2B	Y3A	Y2A
21	22	23	24	25	26	27	28	29	30	31	32	33	34	35	36	37	38	39	40
Y39	Y29	Y38	Y28	Y37	Y27	Y36	Y26	Y35	Y25	Y34	Y24	Y33	Y23	Y32	Y22	Y31	Y21	Y30	Y20

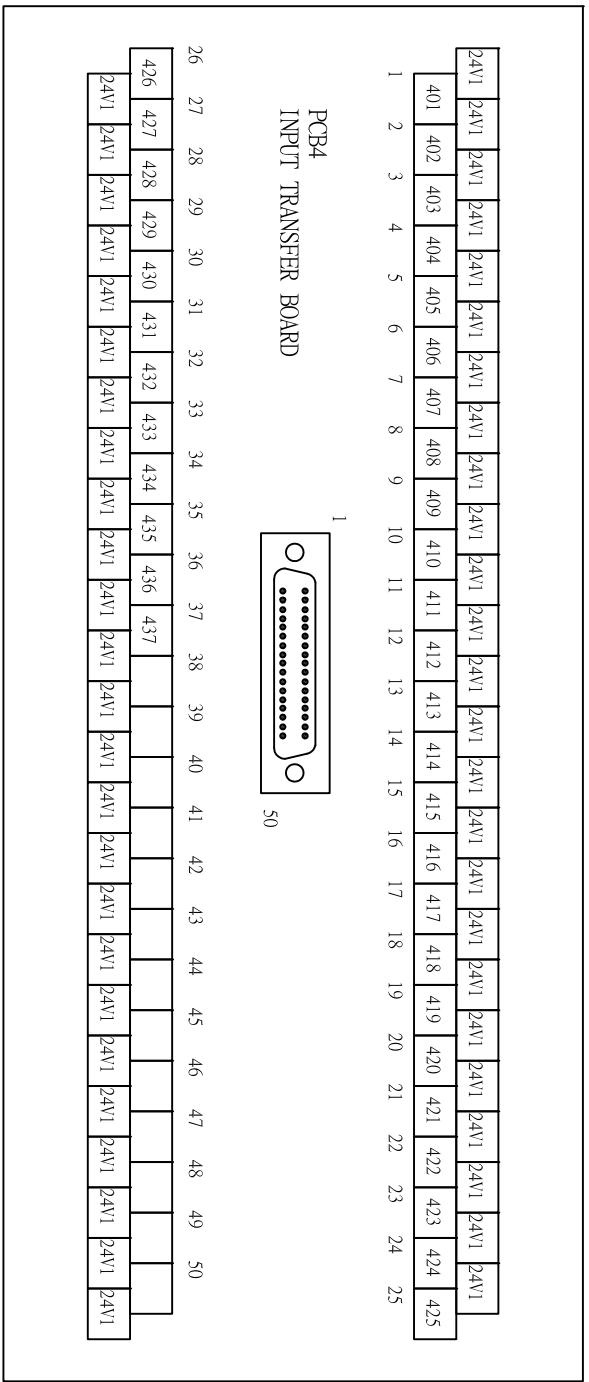

DIL

1	2	3	4	5	6	7	8	9	10	11	12	13	14	15	16	17	18	19	20
0V	24V1	0V	24V1	0V	0V			X1F	XF	X1E	XE	X1D	XD	X1C	XC	X1B	XB	X1A	XA
21	22	23	24	25	26	27	28	29	30	31	32	33	34	35	36	37	38	39	40
X19	X9	X18	X8	X17	X7	X16	X6	X15	X5	X14	X4	X13	X3	X12	X2	X11	X1	X10	X0

DIR

1	2	3	4	5	6	7	8	9	10	11	12	13	14	15	16	17	18	19	20
0V	24V1	0V	24V1	0V	0V			X3F	X2F	X31E	X2E	X31D	X2D	X31C	X2C	X31B	X2B	X31A	X2A
21	22	23	24	25	26	27	28	29	30	31	32	33	34	35	36	37	38	39	40
X39	X29	X38	X28	X37	X27	X36	X26	X35	X25	X34	X24	X33	X23	X32	X22	X31	X21	X30	X20

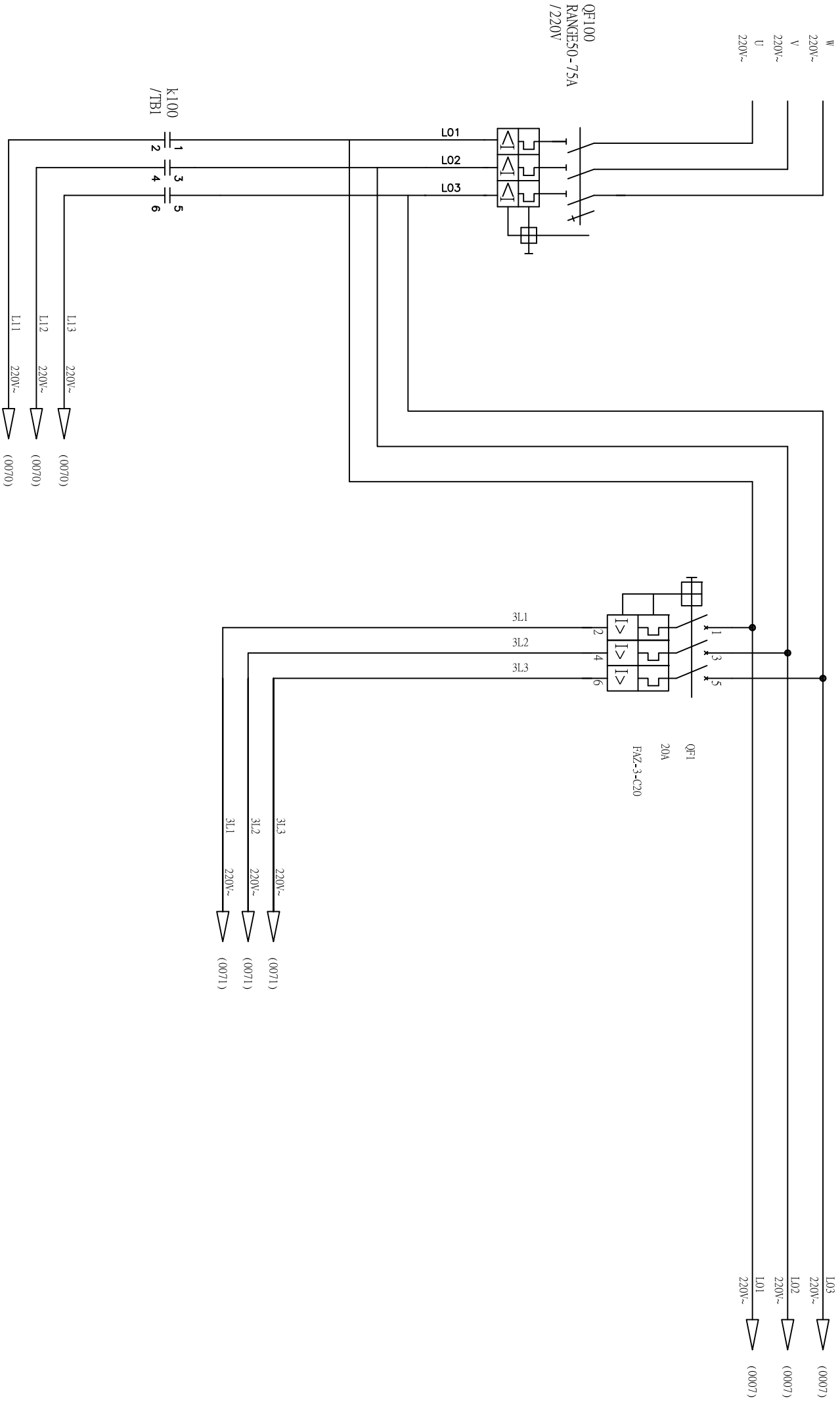

TITLE: POWER LAYOUT



DESIGNER	CONTROL	MACHINE	PAGE	VER
2014/02/14	MITSUBISHI		0006	A

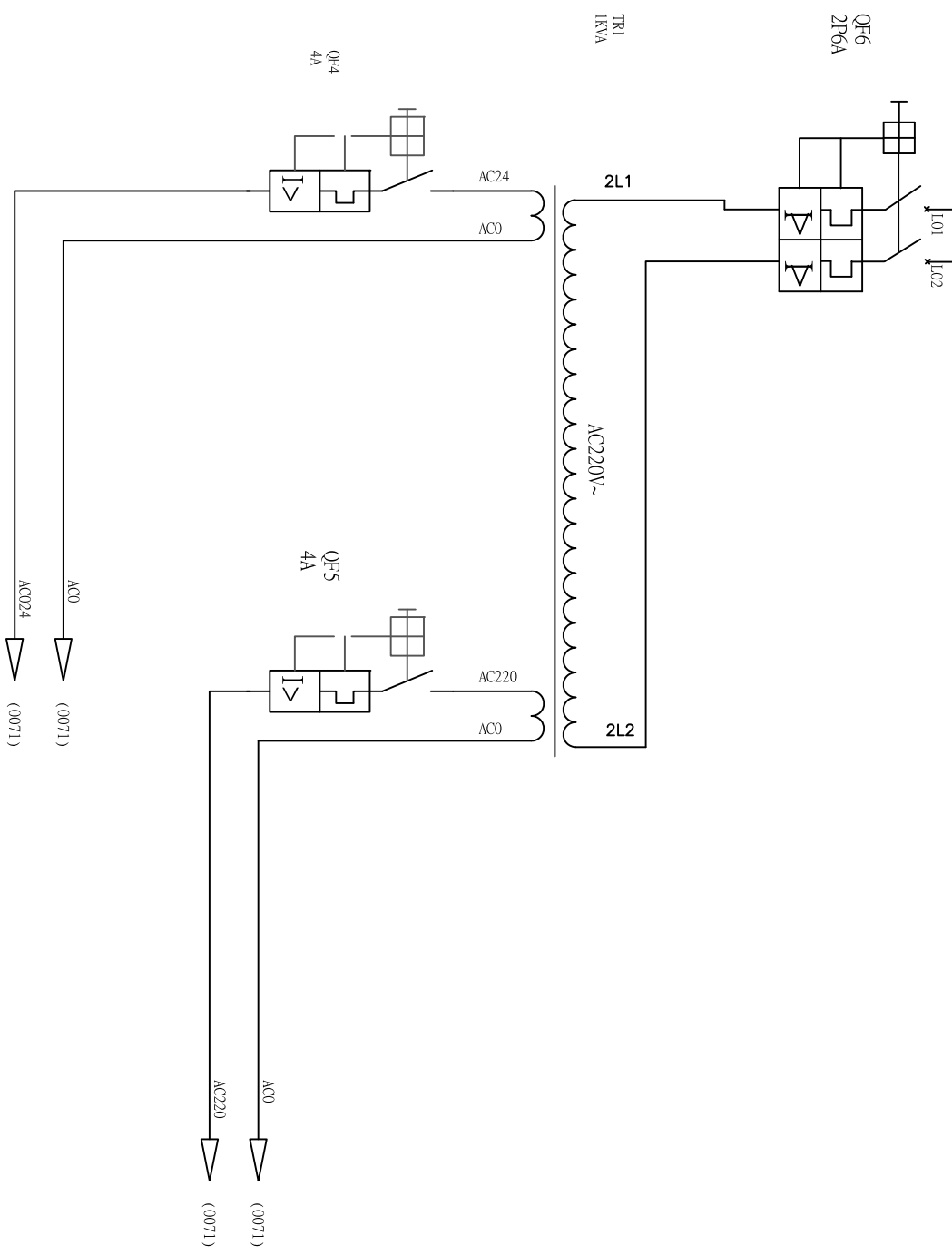
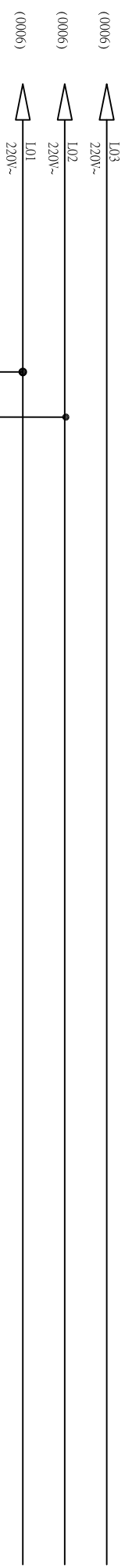

TITLE: POWER SUPPLY AC230V~

LEADERWAY

DESIGNER	CONTROL	MACHINE	PAGE	VER
2014/02/14	mitsubishi		0007	A

1	2	3	4	5	6	7	8	9
---	---	---	---	---	---	---	---	---

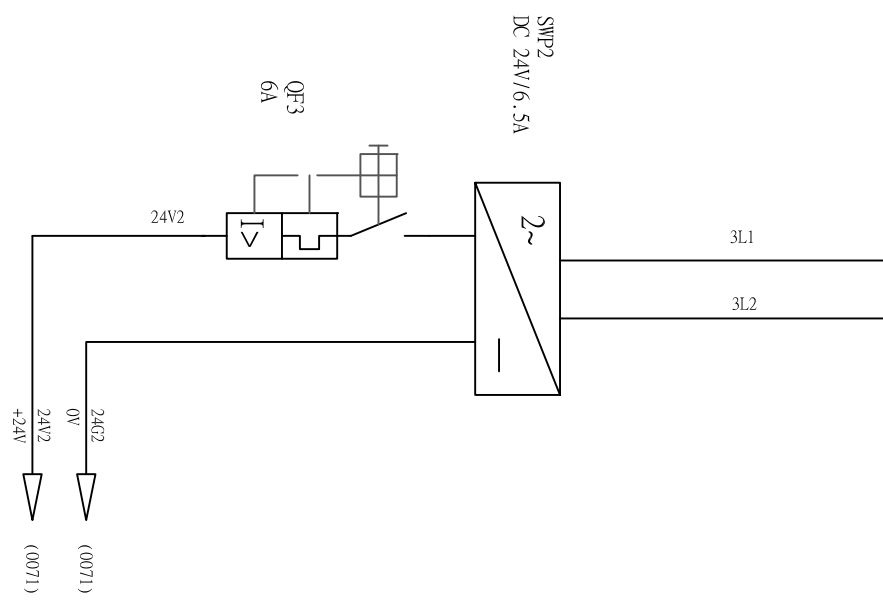
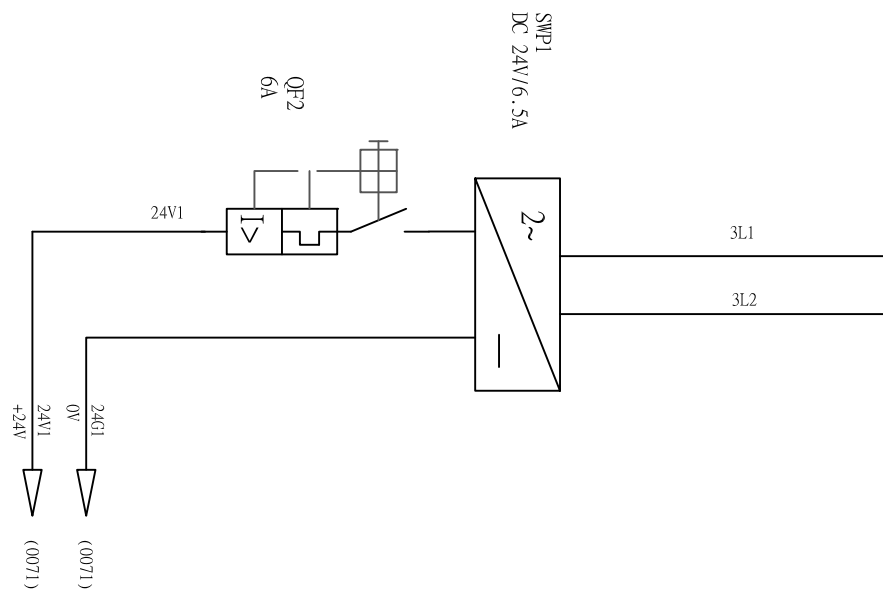
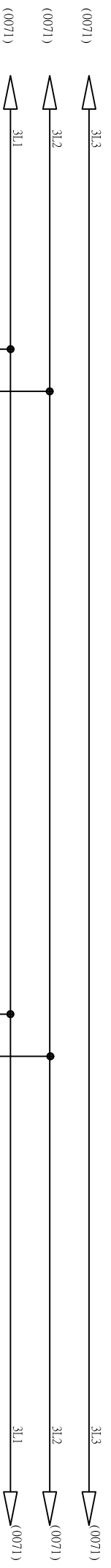

TITLE: POWER SUPPLY DC24V



DESIGNER	CONTROL	MACHINE	PAGE	VER
2014/02/14	MITSUBISHI		0008	A

1	2	3	4	5	6	7	8	9
---	---	---	---	---	---	---	---	---

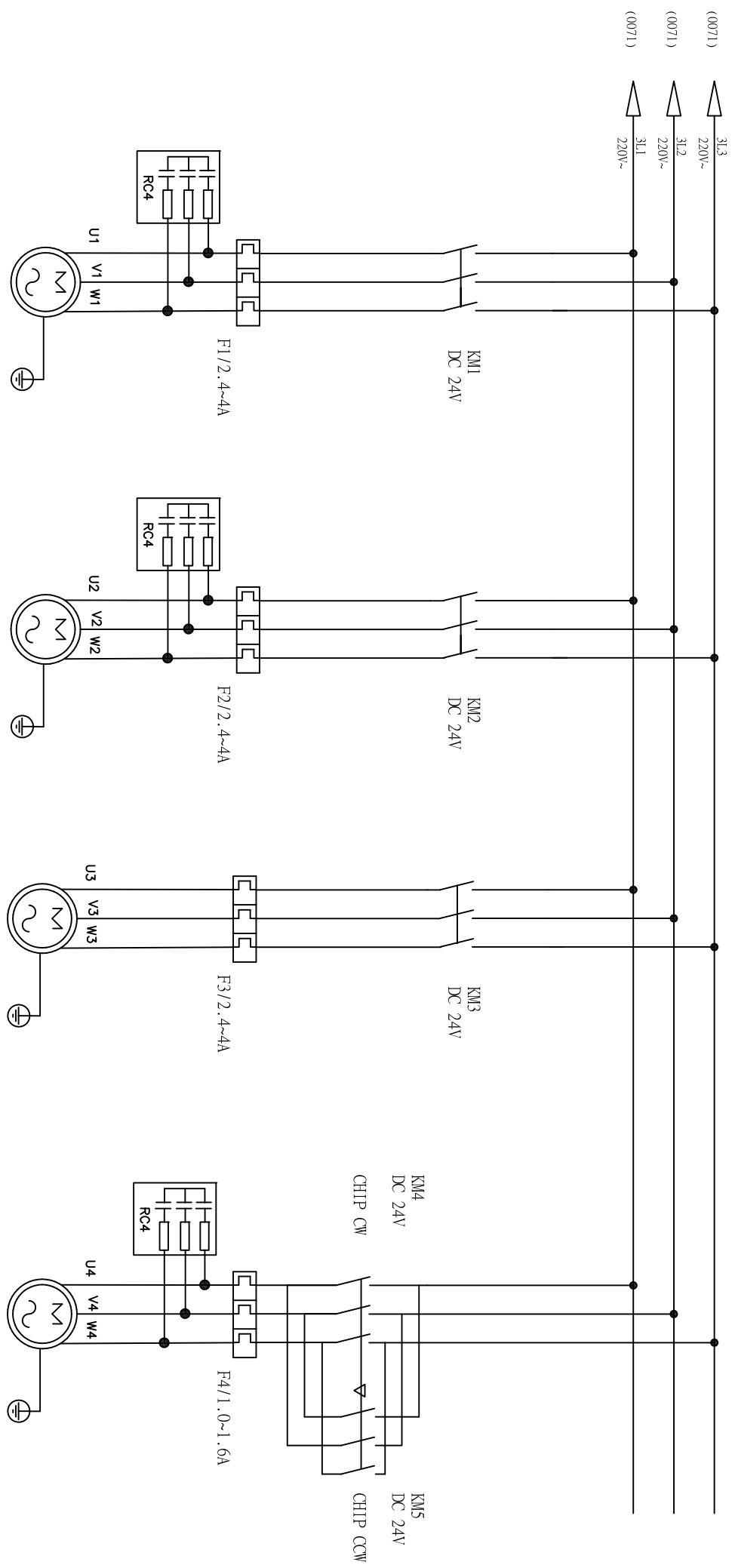

COOLANT A MOTOR

COOLANT B MOTOR

OIL COOLANT MOTOR

CHIP MOTOR

TITLE: ELECTRICAL CABINET BOARD LAYOUT <COOLANT A MOTOR & COOLANT B & OIL COOLANT & CHIP MOTOR>		LEADERWAY		DESIGNER	CONTROL	MACHINE	PAGE	VER
				2014/02/14	MITSUBISHI		0009	A

1	2	3	4	5	6	7	8	9
---	---	---	---	---	---	---	---	---

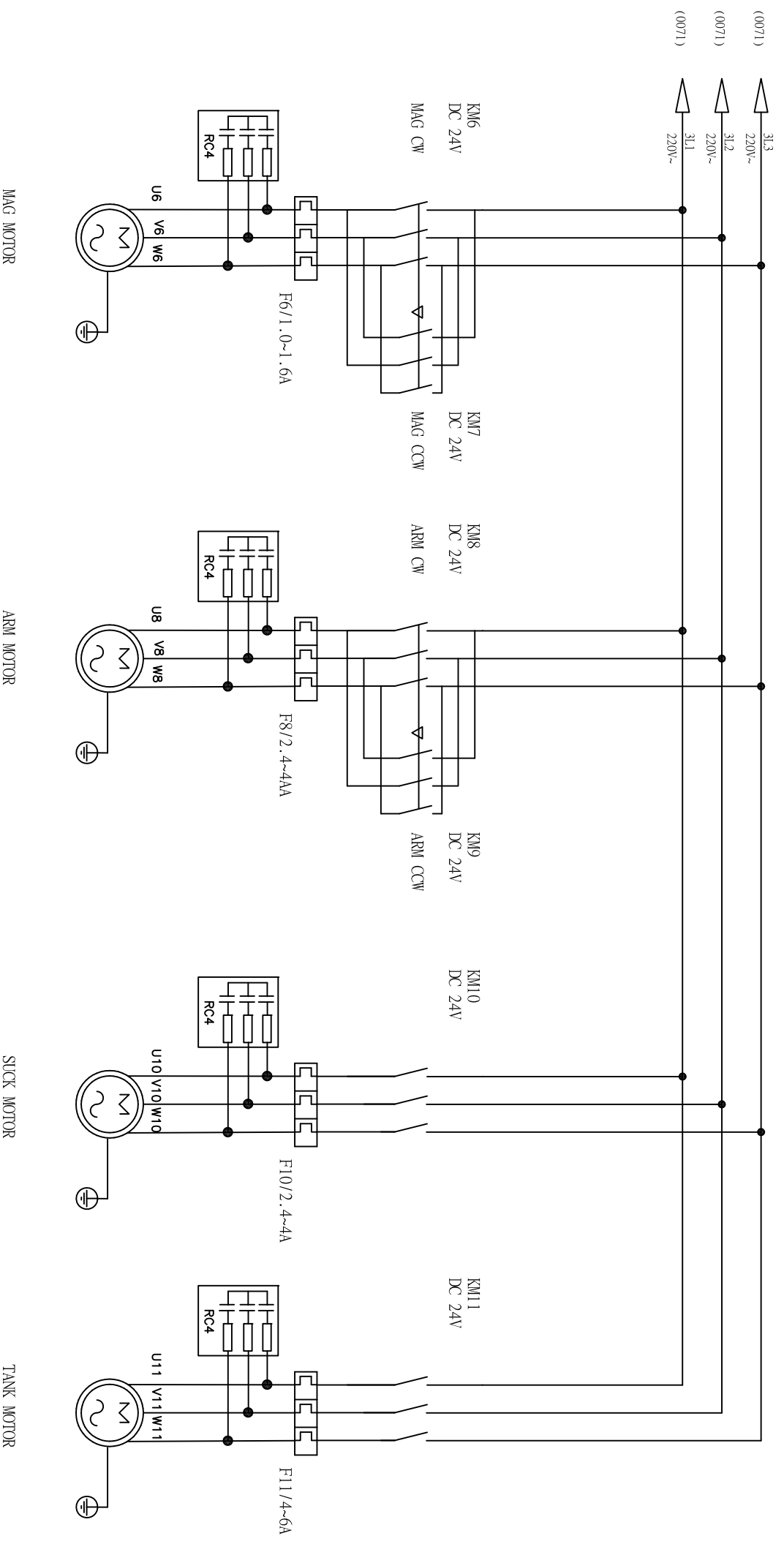

MAG MOTOR

ARM MOTOR

SUCK MOTOR

TANK MOTOR

TITLE: ELECTRICAL CABINET BOARD LAYOUT		LEADERWAY		DESIGNER	CONTROL	MACHINE	PAGE	VER
<MAG MOTOR & ARM MOTOR & CTS SUCK & CTS TANKS>				2014/02/14	MIITSUBISHI		0010	A

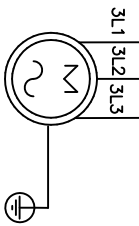
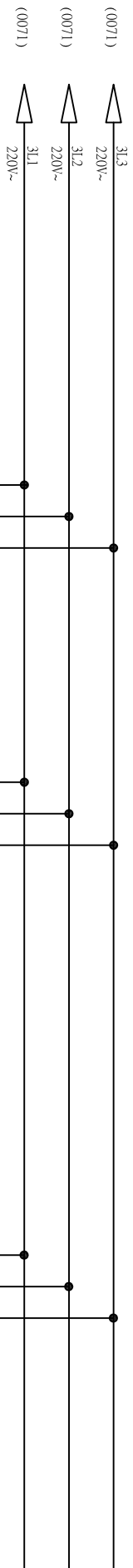

SPINDLE FAN MOTOR

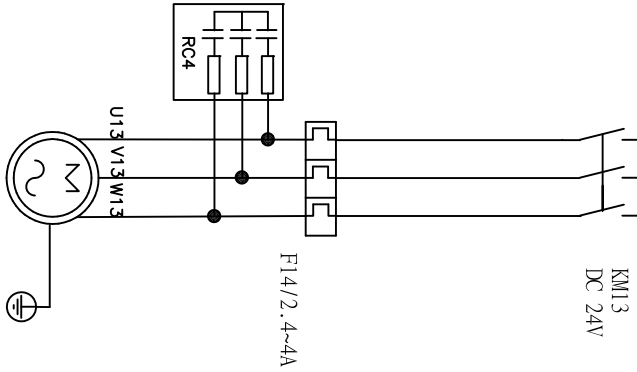

HYDRAULIC MOTOR

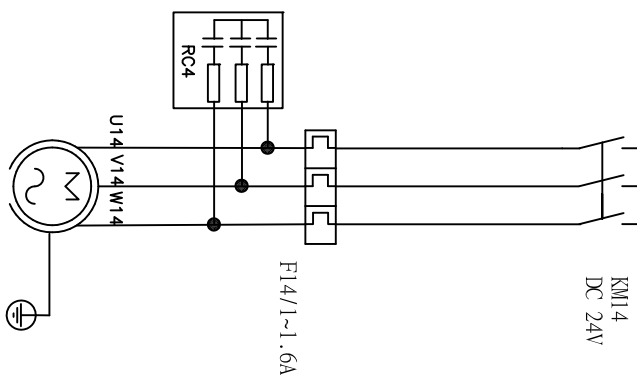

CHAIN MOTOR

TITLE: ELECTRICAL CABINET BOARD LAYOUT <MAG MOTOR & ARM MOTOR & CTS STICK & CTS TANKS>		LEADERWAY		DESIGNER	CONTROL	MACHINE	PAGE	VER
				2014/02/14	MIITSUBISHI		0011	A

MITSUBISHI				
CG31	CG31-A1	CG31-B1	CG31-A2	CG31-B2
	CG31-A3	CG31-B3	CG31-A4	CG31-B4
	CG31-A5	<X21F>	CG31-B5	<X20F>

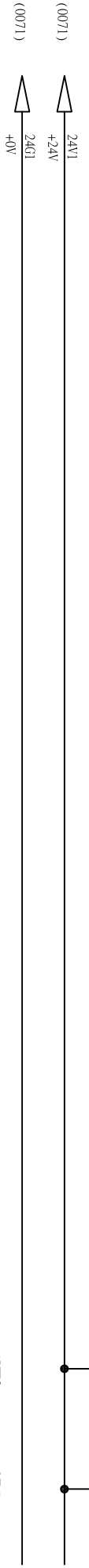
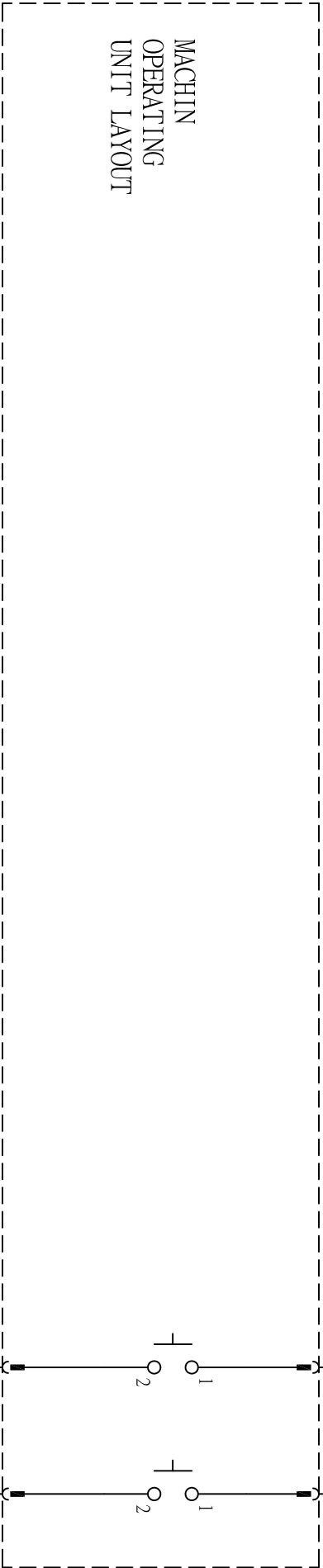

AUTO
MODE
PB

MDI
MODE
PB

mitsubishi

CG31	CG31 -A6 <X21E>	CG31 -B6 <X20E>	CG31 -A7 <X21D>	CG31 -B7 <X20D>	CG31 -A8 <X21C>	CG31 -B8 <X20C>	CG31 -A9 <X21B>	CG31 -B9 <X20B>	CG31 -A10 <X21A>	CG31 -B10 <X20A>
------	--------------------	--------------------	--------------------	--------------------	--------------------	--------------------	--------------------	--------------------	---------------------	---------------------

MACHIN
OPERATING
UNIT LAYOUT

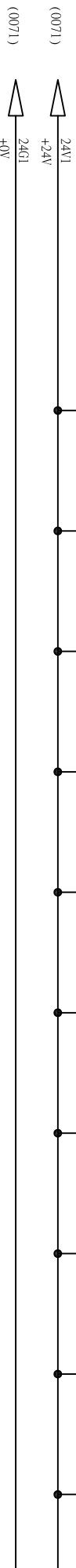

- EDIT MODE PB
- DNC MODE PB
- SINGLE BLOCK PB
- DRY RUN PB
- BLOCK DELETE PB
- OPTION STOP PB
- PROG. RESTART PB
- MPG MODE PB
- JOG MODE PB
- HOME MODE PB

mitsubishi

CG31	CG31-A11	CG31-B11	CG31-A12	CG31-B12	CG31-A13	CG31-B13	CG31-A14	CG31-B14	CG31-A15	CG31-B15
	<X219>	<X209>	<X218>	<X208>	<X217>	<X207>	<X216>	<X206>	<X215>	<X205>

MACHIN
OPERATING
UNIT LAYOUT

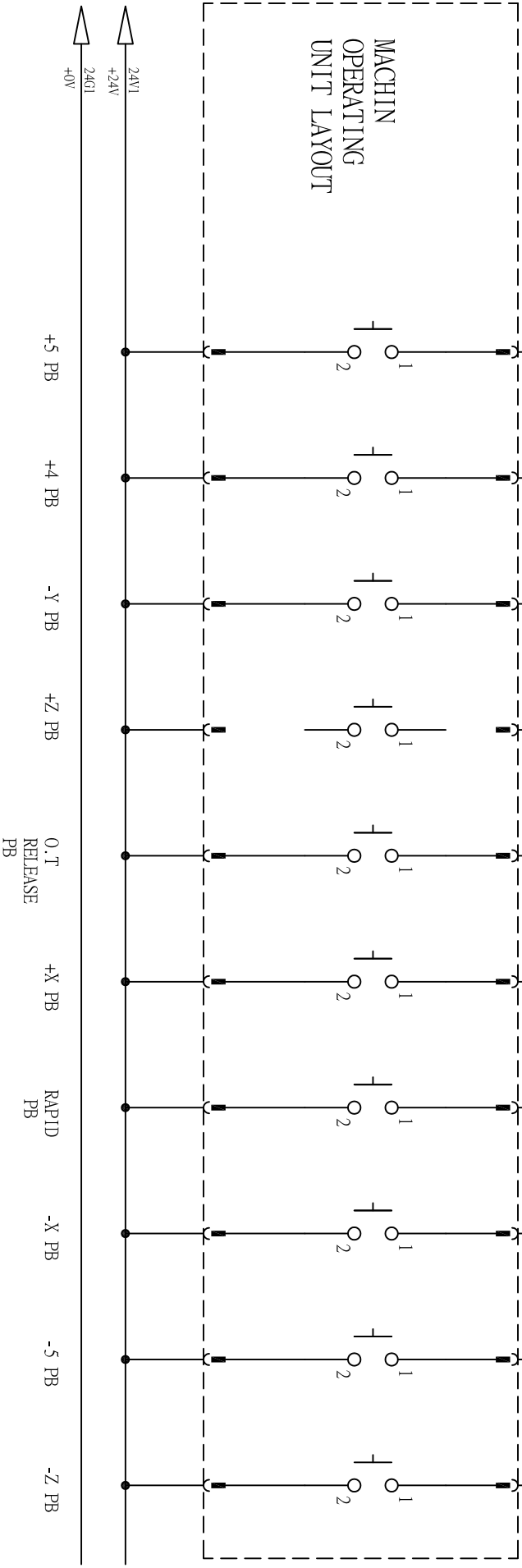

mitsubishi

CG31	CG31-A16	CG31-B16	CG31-A17	CG31-B17	CG31-A18	CG31-B18	CG31-A19	CG31-B19	CG31-A20	CG31-B20
	<X214>	<X204>	<X213>	<X203>	<X212>	<X202>	<X211>	<X201>	<X210>	<X200>

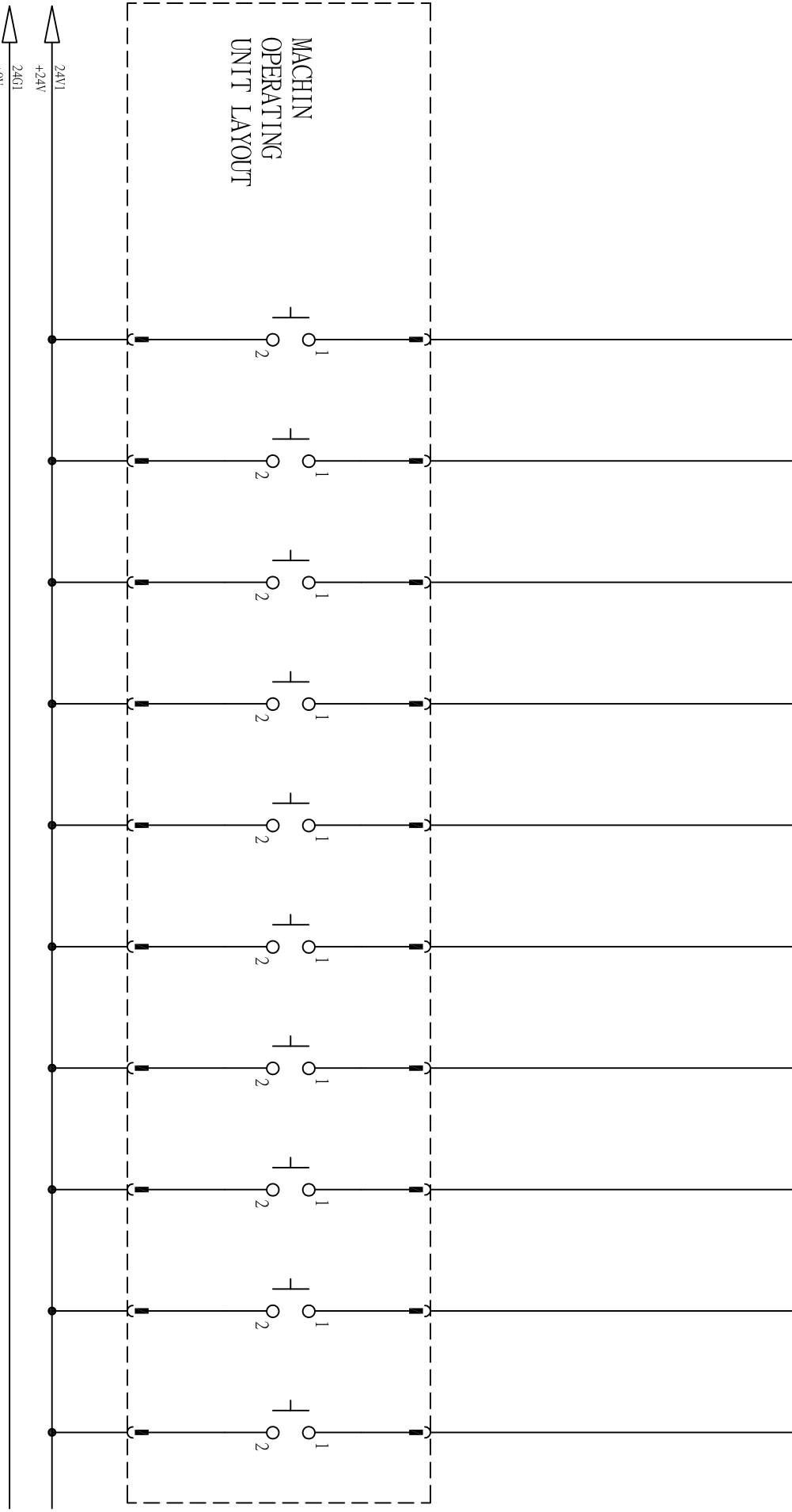

MACHIN
OPERATING
UNIT LAYOUT

MITSUBISHI	
CG33	CG33-A1 CG33-B1 CG33-A2 CG33-B2 CG33-A3 CG33-B3 CG33-A4 CG33-B4 CG33-A5 <X23F> CG33-B5 <X22F>

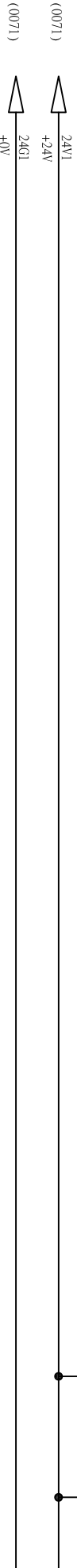
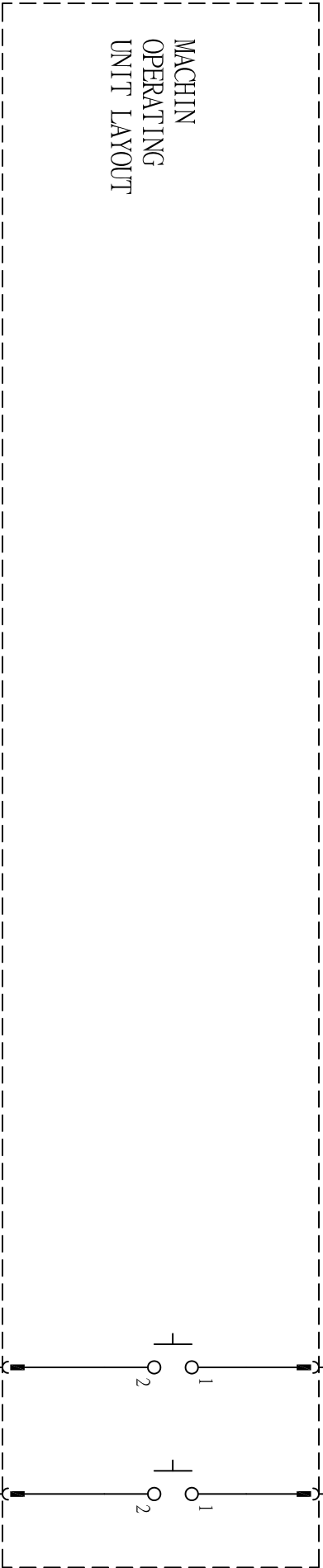

WORK SPINDLE
 LIGHT AIR BLOW
 PB PB

mitsubishi

CG33	CG33-A6	<X23E>	CG33-B6	<X22E>	CG33-A7	<X23D>	CG33-B7	<X22D>	CG33-A8	<X23C>	CG33-B8	<X22C>	CG33-A9	<X23B>	CG33-B9	<X22B>	CG33-A10	<X23A>	CG33-B10	<X22A>
------	---------	--------	---------	--------	---------	--------	---------	--------	---------	--------	---------	--------	---------	--------	---------	--------	----------	--------	----------	--------

MACHIN
OPERATING
UNIT LAYOUT

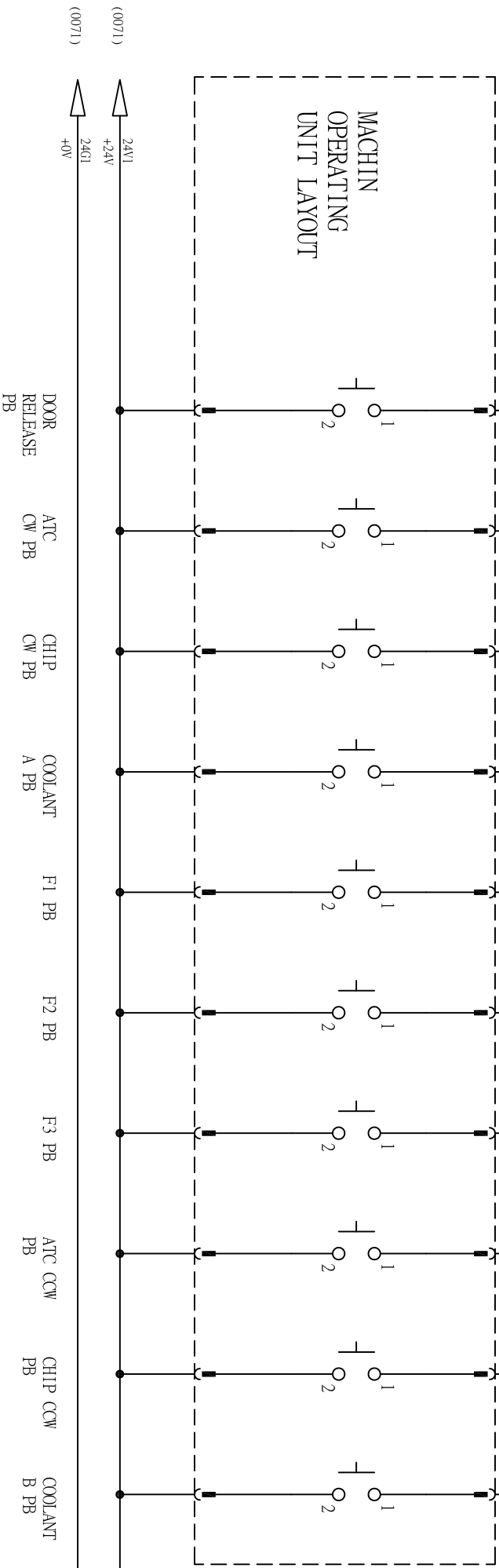

mitsubishi

CG33	CG33-A11	CG33-B11	CG33-A12	CG33-B12	CG33-A13	CG33-B13	CG33-A14	CG33-B14	CG33-A15	CG33-B15
	<X239>	<X229>	<X238>	<X228>	<X237>	<X227>	<X236>	<X226>	<X235>	<X225>

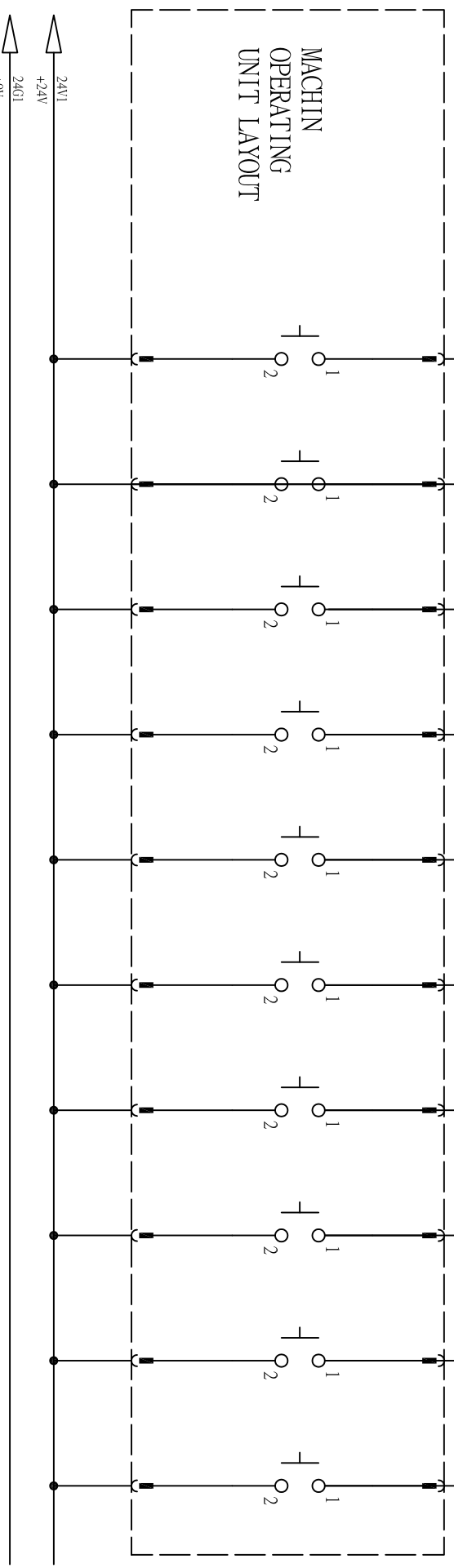

mitsubishi

CG33	CG33-A16	CG33-B16	CG33-A17	CG33-B17	CG33-A18	CG33-B18	CG33-A19	CG33-B19	CG33-A20	CG33-B20
	<X234>	<X224>	<X233>	<X223>	<X232>	<X222>	<X231>	<X221>	<X230>	<X220>

MACHIN
OPERATING
UNIT LAYOUT

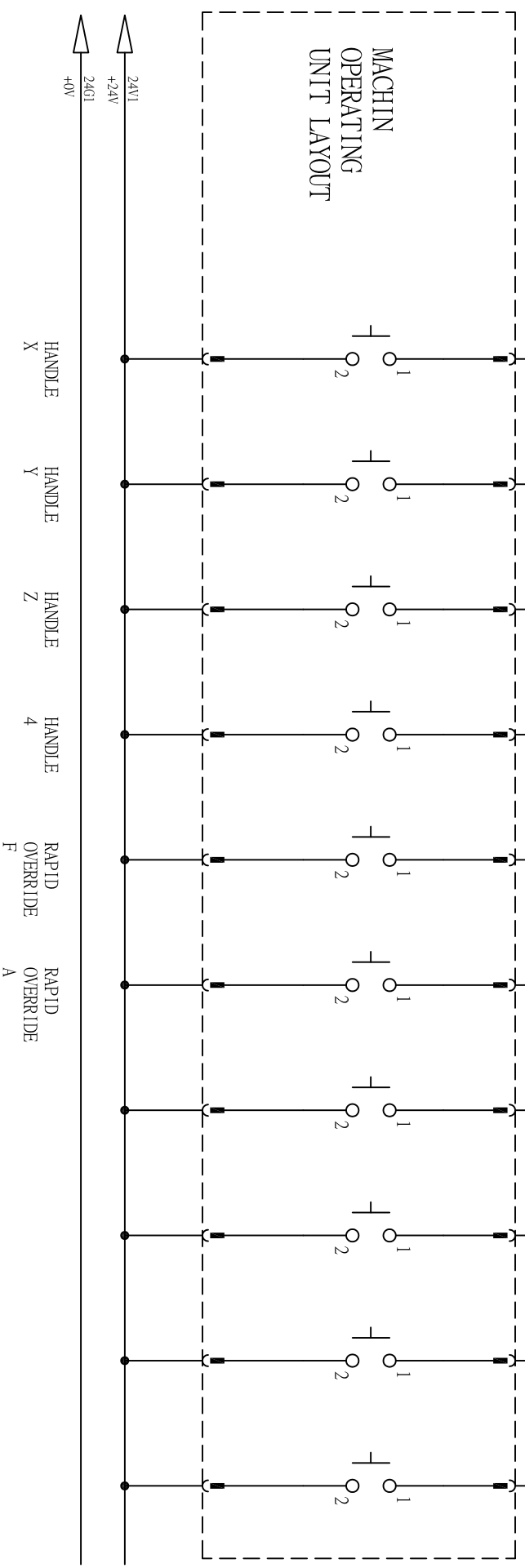

MITSUBISHI				
CG32	CG32-A1	CG32-B1	CG32-A2	CG32-B2
	CG32-A3	CG32-B3	CG32-A4	CG32-B4
	CG32-A5	<Y21F>	CG32-B5	<Y20F>

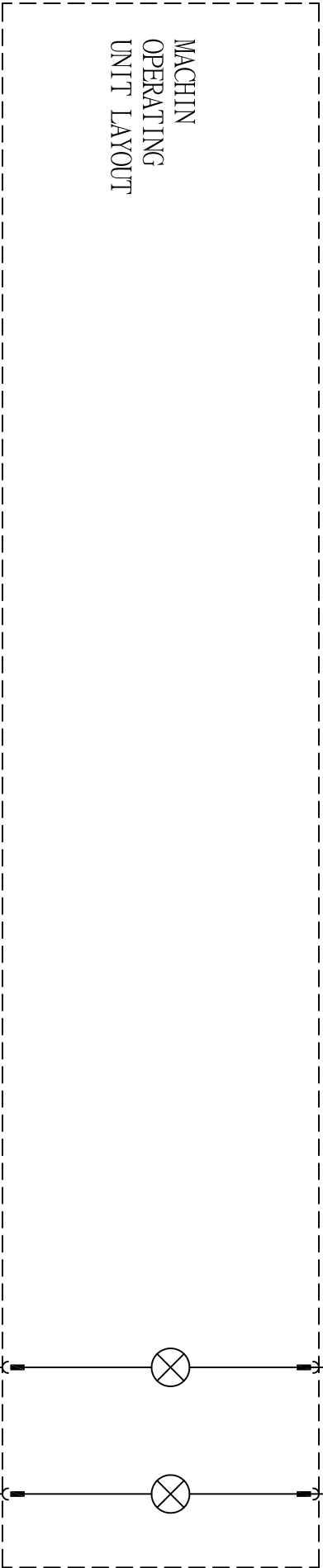

MACHIN
OPERATING
UNIT LAYOUT

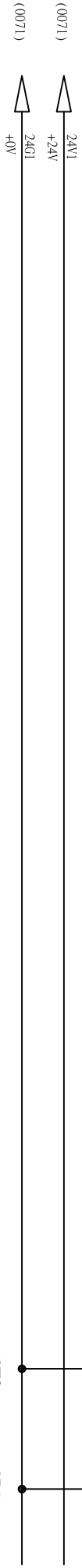

AUTO
MODE
LED

MDI
MODE
LED

mitsubishi

CGC32	CG32-A6 <Y21E>	CG32-B6 <Y20E>	CG32-A7 <Y21D>	CG32-B7 <Y20D>	CG32-A8 <Y21C>	CG32-B8 <Y20C>	CG32-A9 <Y21B>	CG32-B9 <Y20B>	CG32-A10 <Y21A>	CG32-B10 <Y20A>
-------	-------------------	-------------------	-------------------	-------------------	-------------------	-------------------	-------------------	-------------------	--------------------	--------------------

MACHIN
OPERATING
UNIT LAYOUT

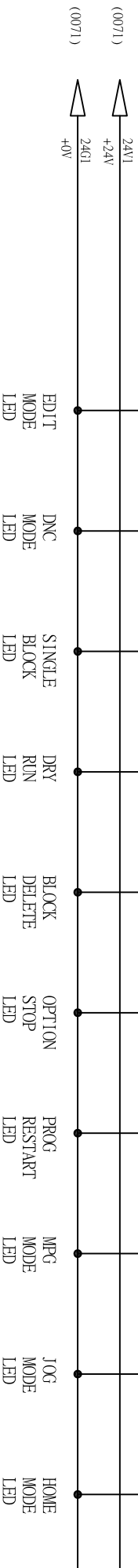

TITLE: ELECTRICAL CABINET BOARD LAYOUT

DO-L - OUTPUT LAYOUT



DESIGNER
2014/02/14

CONTROL
mitsubishi

MACHINE

PAGE
0021

VER
A

mitsubishi

CG32	CG32-A11	CG32-B11	CG32-A12	CG32-B12	CG32-A13	CG32-B13	CG32-A14	CG32-B14	CG32-A15	CG32-B15
	<Y219>	<Y209>	<Y218>	<Y208>	<Y217>	<Y207>	<Y216>	<Y206>	<Y215>	<Y205>

MACHIN
OPERATING
UNIT LAYOUT

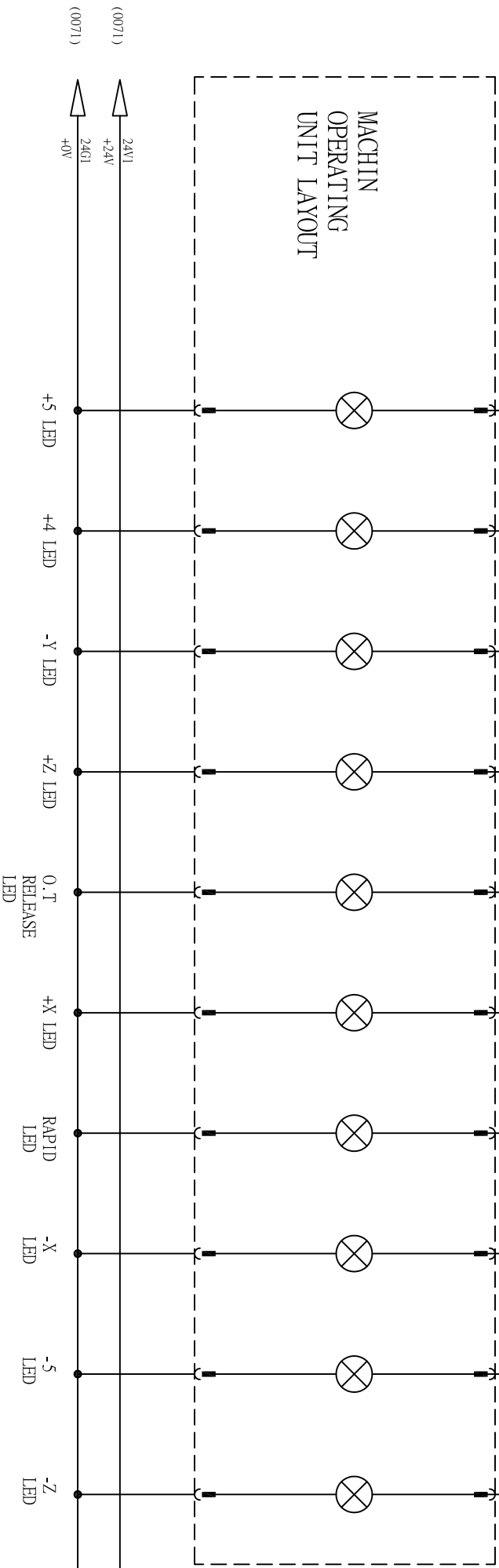

TITLE: ELECTRICAL CABINET BOARD LAYOUT
DO-L - OUTPUT LAYOUT



DESIGNER	CONTROL	MACHINE	PAGE	VER
2014/02/14	MITSUBISHI		0022	A

mitsubishi

CG32	CG32-A16	CG32-B16	CG32-A17	CG32-B17	CG32-A18	CG32-B18	CG32-A19	CG32-B19	CG32-A20	CG32-B20
	<Y214>	<Y204>	<Y213>	<Y203>	<Y212>	<Y202>	<Y211>	<Y201>	<Y210>	<Y200>

MACHIN
OPERATING
UNIT LAYOUT

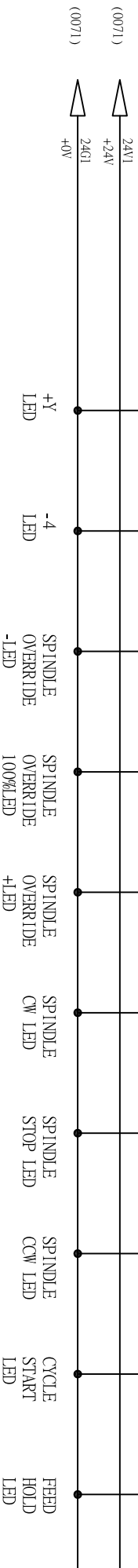

TITLE: ELECTRICAL CABINET BOARD LAYOUT

DO-L - OUTPUT LAYOUT



DESIGNER	CONTROL	MACHINE	PAGE	VER
2014/02/14	mitsubishi		0023	A

MITSUBISHI				
CG34	CG34-A1	CG34-B1	CG34-A2	CG34-B2
			CG34-A3	CG34-B3
			CG34-A4	CG34-B4
			<Y23F>	CG34-A5
			<Y22F>	CG34-B5

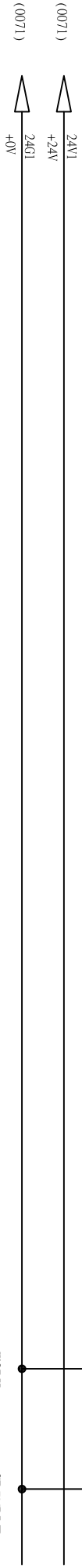
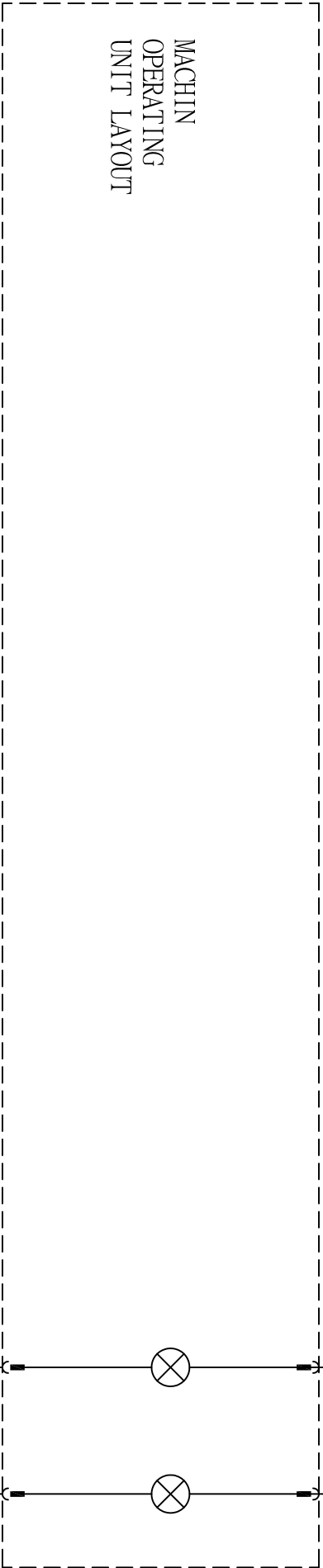

WORK
LIGHT
LED

SPINDLE
AIR BLOW
LED

mitsubishi

CG34	CG34-A6	CG34-B6	CG34-A7	CG34-B7	CG34-A8	CG34-B8	CG34-A9	CG34-B9	CG34-A10	CG34-B10
	<Y23E>	<Y22E>	<Y23D>	<Y22D>	<Y23C>	<Y22C>	<Y23B>	<Y22B>	<Y23A>	<Y22A>

MACHIN
OPERATING
UNIT LAYOUT

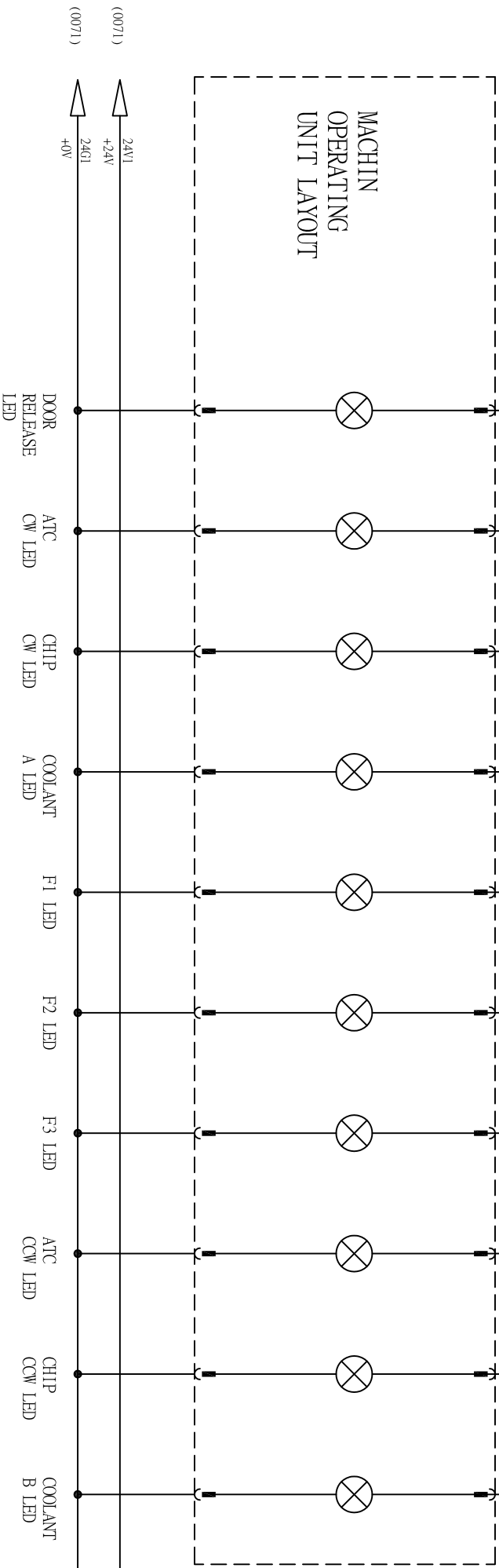

mitsubishi

CG34	CG34-A11	CG34-B11	CG34-A12	CG34-B12	CG34-A13	CG34-B13	CG34-A14	CG34-B14	CG34-A15	CG34-B15
	<Y239>	<Y229>	<Y238>	<Y228>	<Y237>	<Y227>	<Y236>	<Y226>	<Y235>	<Y225>

MACHIN
OPERATING
UNIT LAYOUT

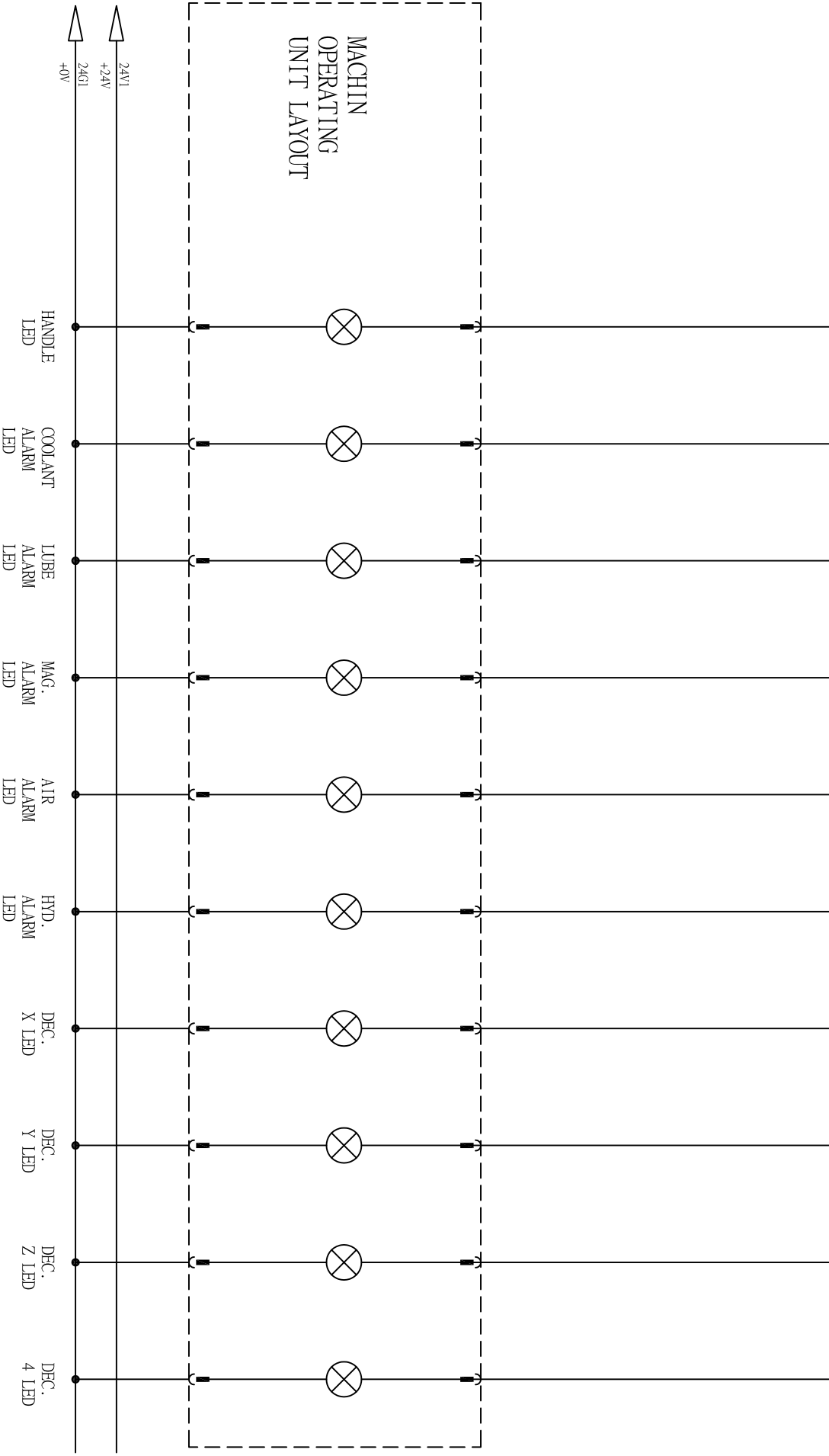

mitsubishi

CG34	CG34-A16	CG34-B16	CG34-A17	CG34-B17	CG34-A18	CG34-B18	CG34-A19	CG34-B19	CG34-A20	CG34-B20
	<Y234>	<Y224>	<Y233>	<Y223>	<Y232>	<Y222>	<Y231>	<Y221>	<Y230>	<Y220>

MACHIN
OPERATING
UNIT LAYOUT

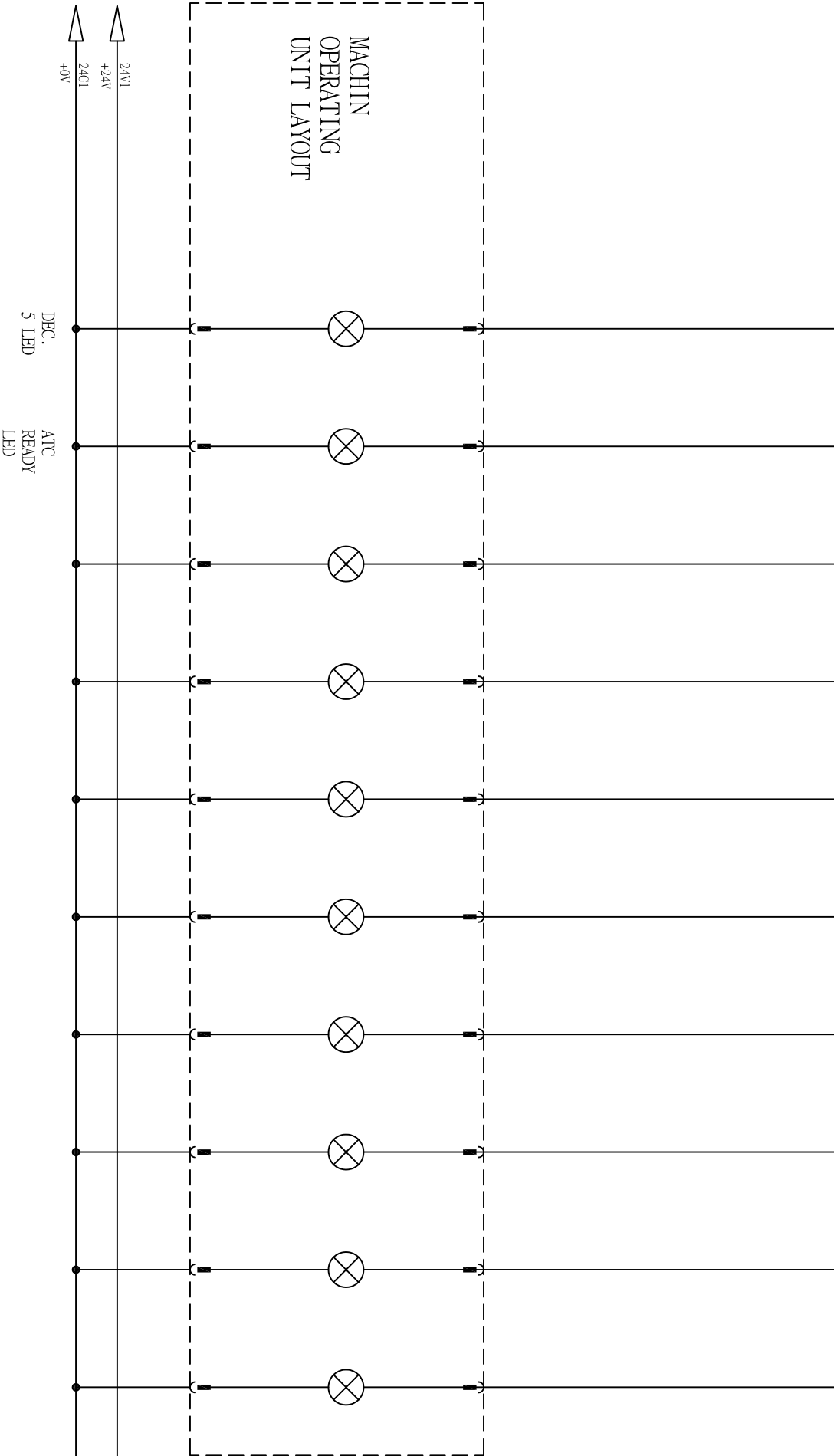

TITLE: ELECTRICAL CABINET BOARD LAYOUT

DO-R - OUTPUT LAYOUT



DESIGNER	CONTROL	MACHINE	PAGE	VER
2014/02/14	MITSUBISHI		0027	A

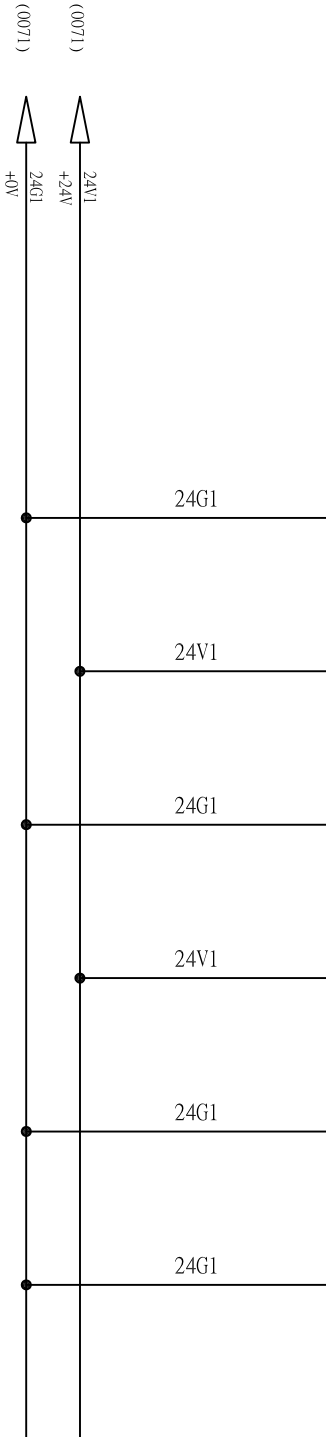
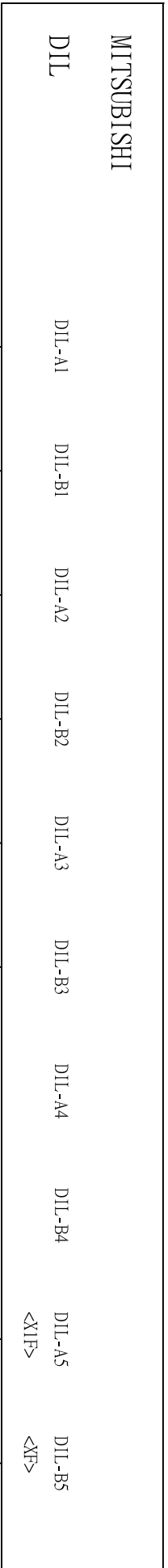

MTSUBISHI

DIL

DIL-A6	<XIB>
DIL-B6	<XB>
DIL-A7	<XID>
DIL-B7	<XD>
DIL-A8	<XIC>
DIL-B8	<XC>
DIL-A9	<XIB>
DIL-B9	<XB>
DIL-A10	<XIA>
DIL-B10	<XA>

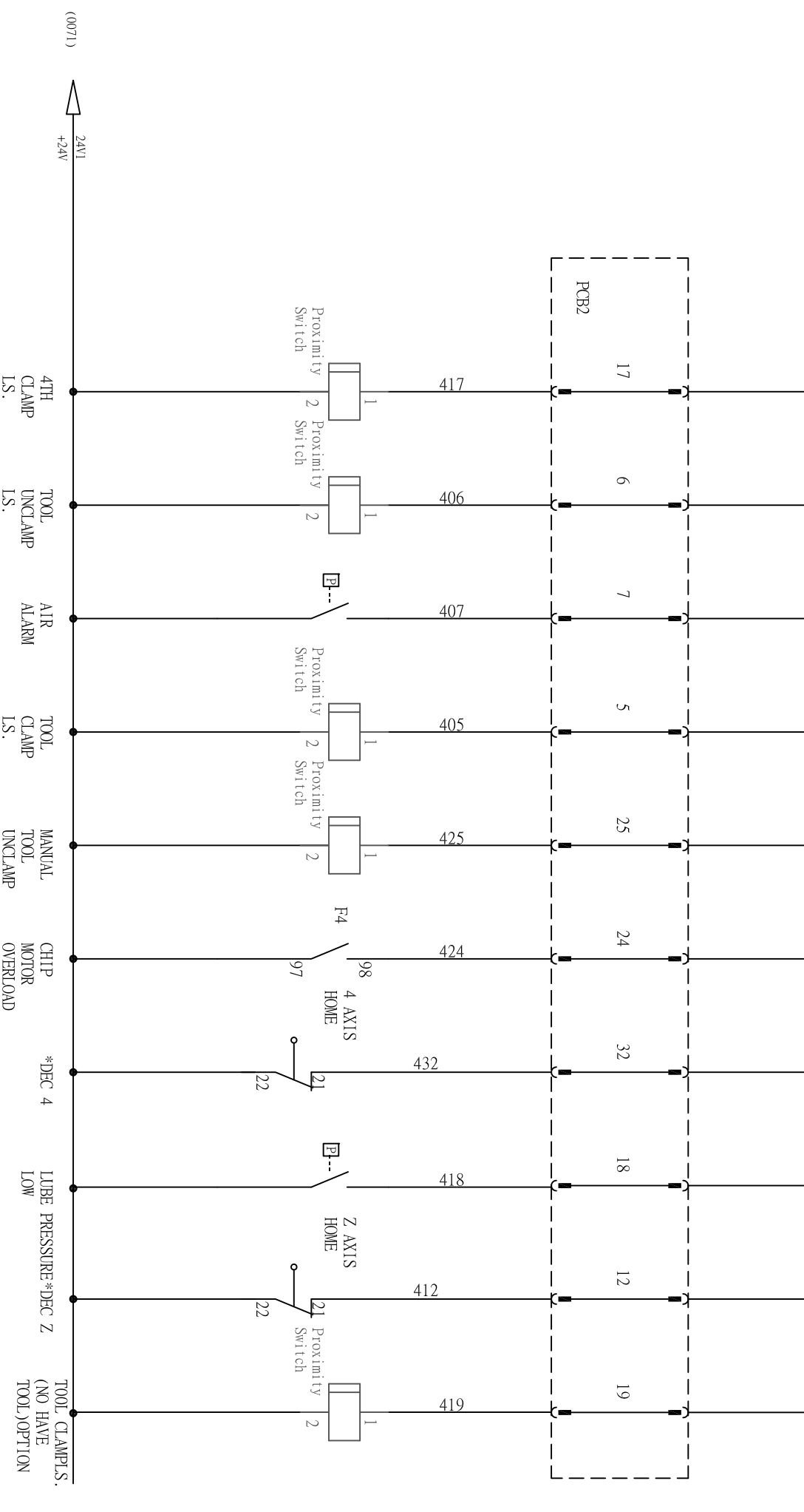

MTSUBISHI

DIL

DIL-A11	<X19>
DIL-B11	<X9>
DIL-A12	<X18>
DIL-B12	<X8>
DIL-A13	<X17>
DIL-B13	<X7>
DIL-A14	<X16>
DIL-B14	<X6>
DIL-A15	<X15>
DIL-B15	<X5>

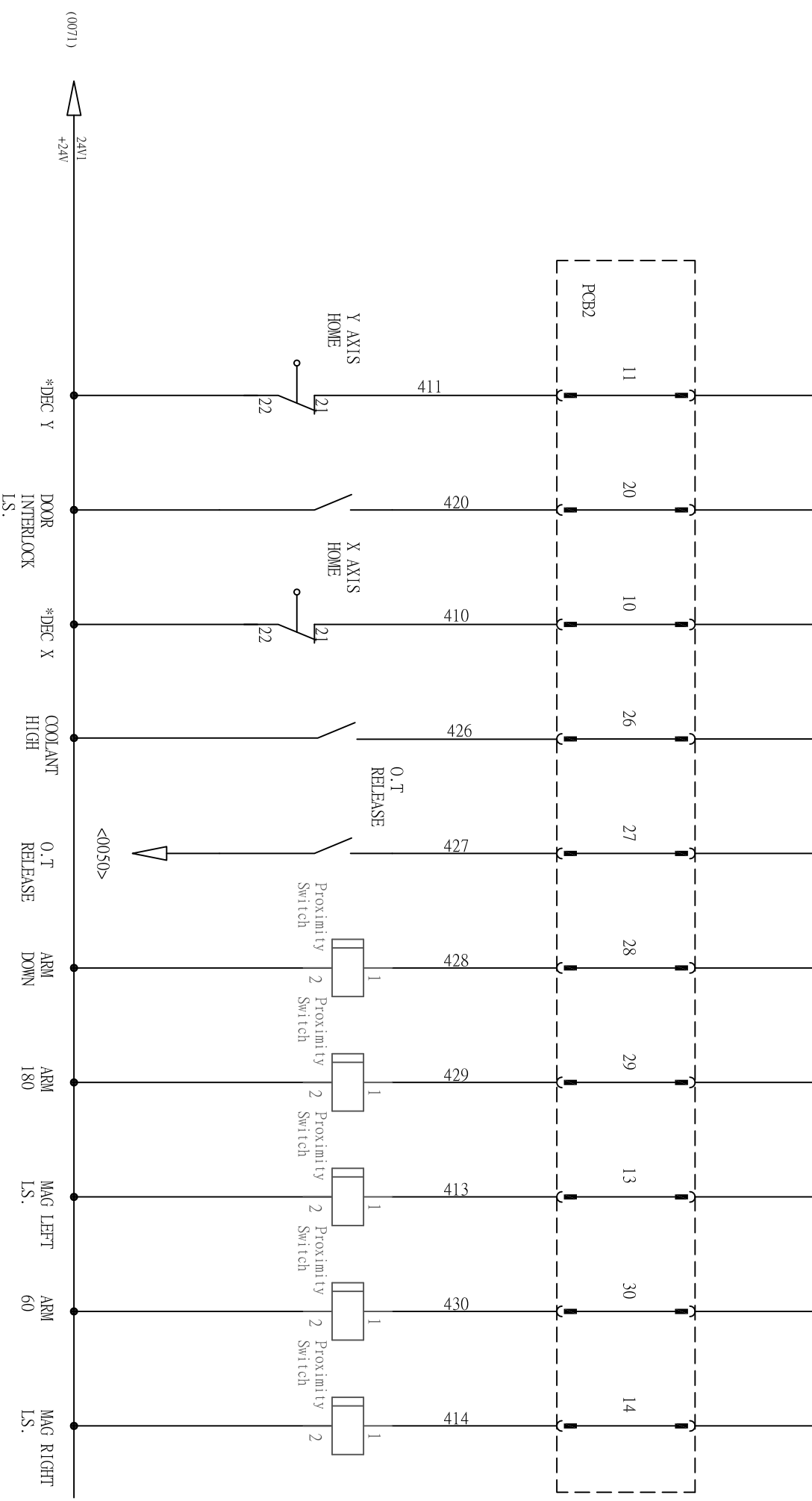

(0071) +24V

MTSUBISHI

DIL

- DIL-A16 <X14>
- DIL-B16 <X4>
- DIL-A17 <X13>
- DIL-B17 <X3>
- DIL-A18 <X12>
- DIL-B18 <X2>
- DIL-A19 <X11>
- DIL-B19 <X1>
- DIL-A20 <X10>
- DIL-B20 <X0>

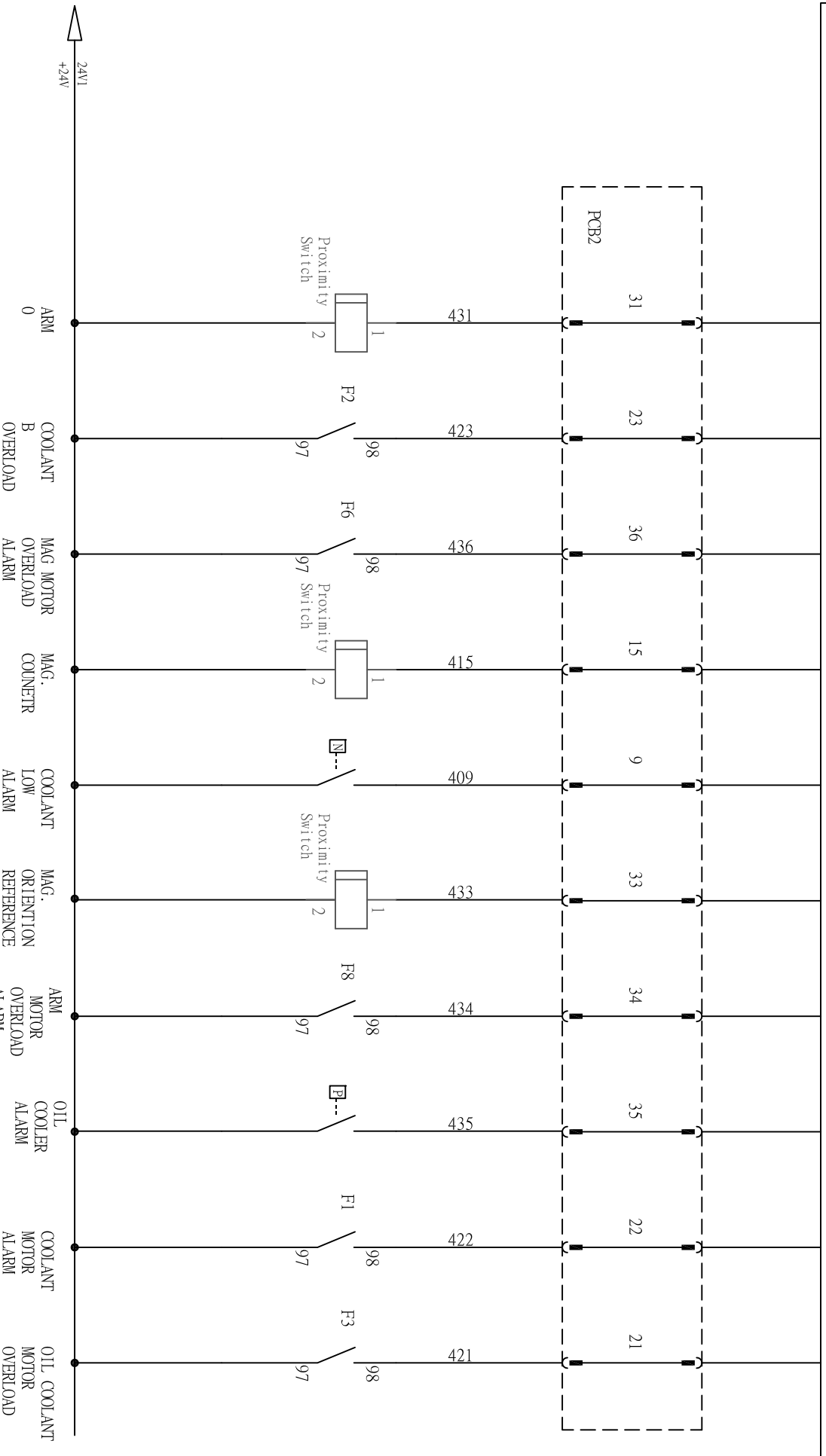

TITLE: ELECTRICAL CABINET BOARD LAYOUT

CF31 - INPUT LAYOUT



DESIGNER	CONTROL	MACHINE	PAGE	VER
2014/02/14	MTSUBISHI		0031	A

MITSUBISHI								
DIR	DIR-A1	DIR-B1	DIR-A2	DIR-B2	DIR-A3	DIR-B3	DIR-A4	DIR-B4
							<X3F>	DIR-A5
								<X2F>
								DIR-B5

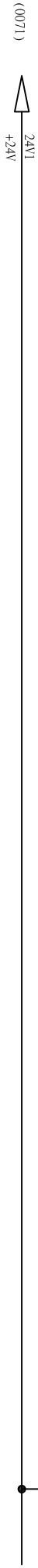
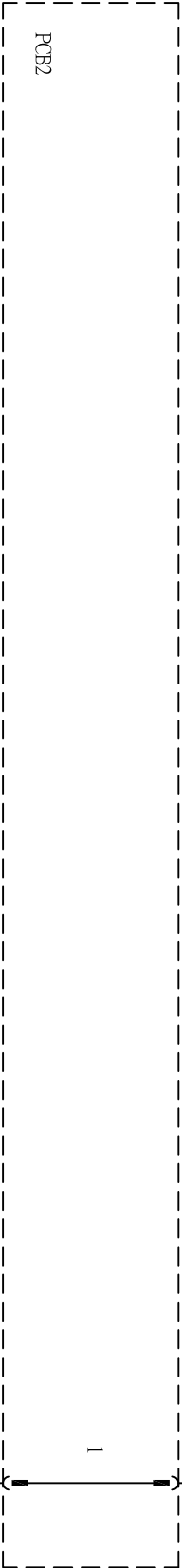

mitsubishi

DIR	DIR-A6	DIR-B6	DIR-A7	DIR-B7	DIR-A8	DIR-B8	DIR-A9	DIR-B9	DIR-A10	DIR-B10
	<X3E>	<X2E>	<X3D>	<X2D>	<X3C>	<X2C>	<X3B>	<X2B>	<X3A>	<X2A>

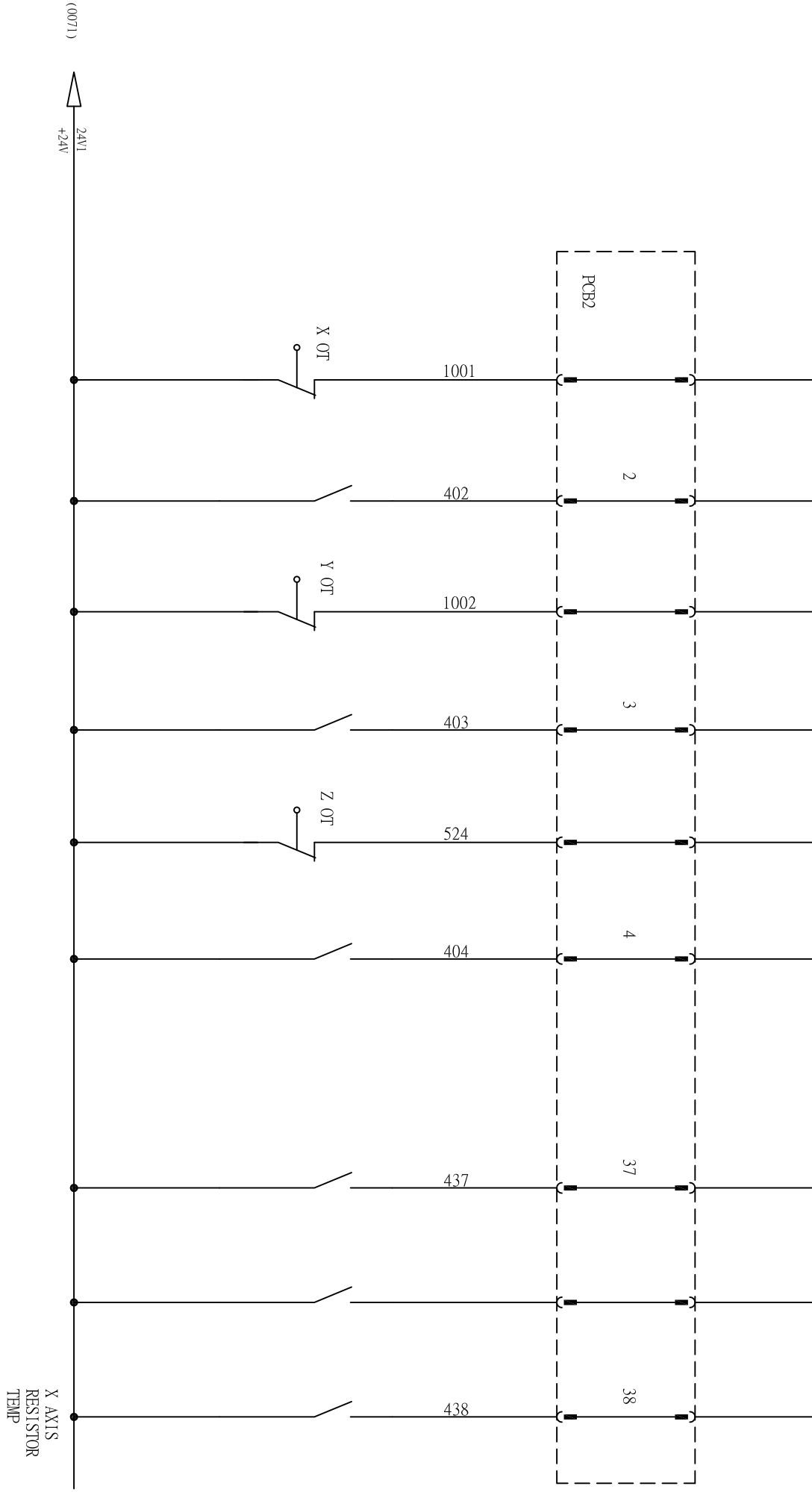

MITSUBISHI				
DIR	DIR-A11	DIR-B11	DIR-A12	DIR-B12
	<X39>	<X29>	<X38>	<X28>
			DIR-A13	DIR-B13
			<X37>	<X27>
			DIR-A14	DIR-B14
			<X36>	<X26>
			DIR-A15	DIR-B15
			<X35>	<X25>

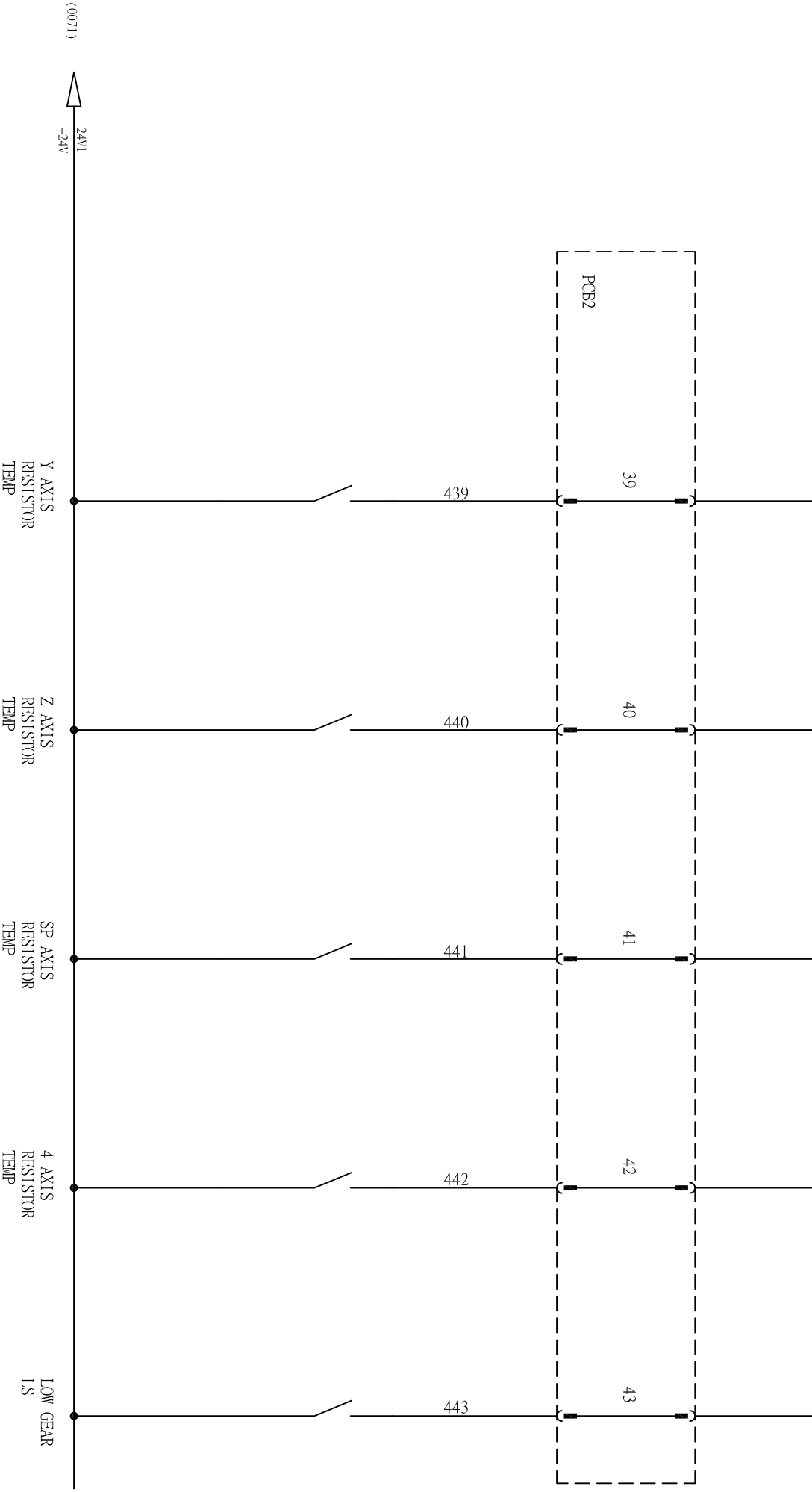

TITLE: ELECTRICAL CABINET BOARD LAYOUT
CF31 - INPUT LAYOUT



DESIGNER	CONTROL	MACHINE	PAGE	VER
2014/02/14	MITSUBISHI		0034	A

MITSUBISHI										
DIR	DIR-A16	DIR-B16	DIR-A17	DIR-B17	DIR-A18	DIR-B18	DIR-A19	DIR-B19	DIR-A20	DIR-B20
	<X34>	<X24>	<X33>	<X23>	<X32>	<X22>	<X31>	<X21>	<X30>	<X20>

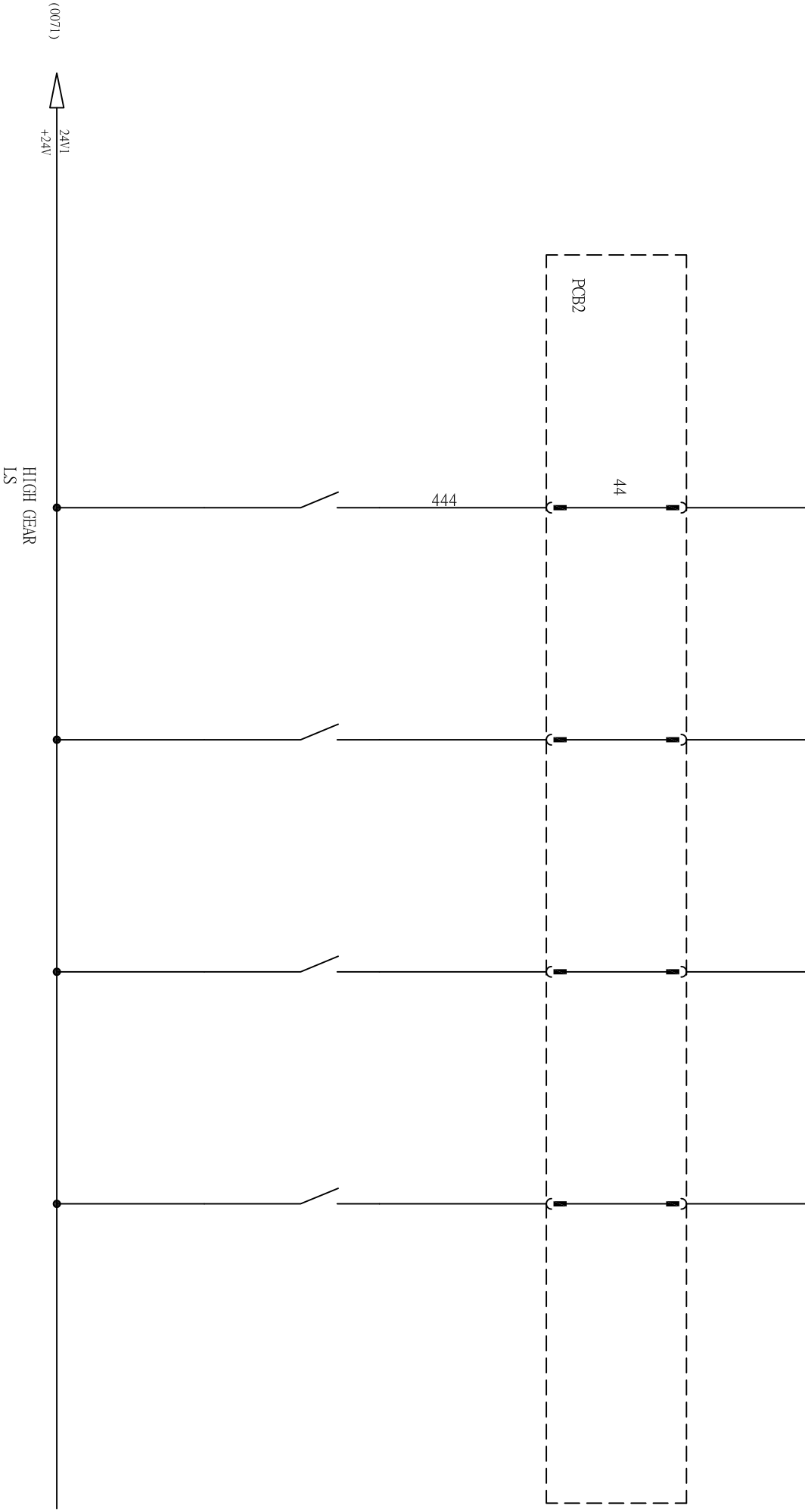

DAIICHI DAIICHI				
DOL	DOL-A1	DOL-B1	DOL-A2	DOL-B2
	DOL-A3	DOL-B3	DOL-A4	DOL-B4
	DOL-A5	DOL-B5	<XIF>	<XIF>

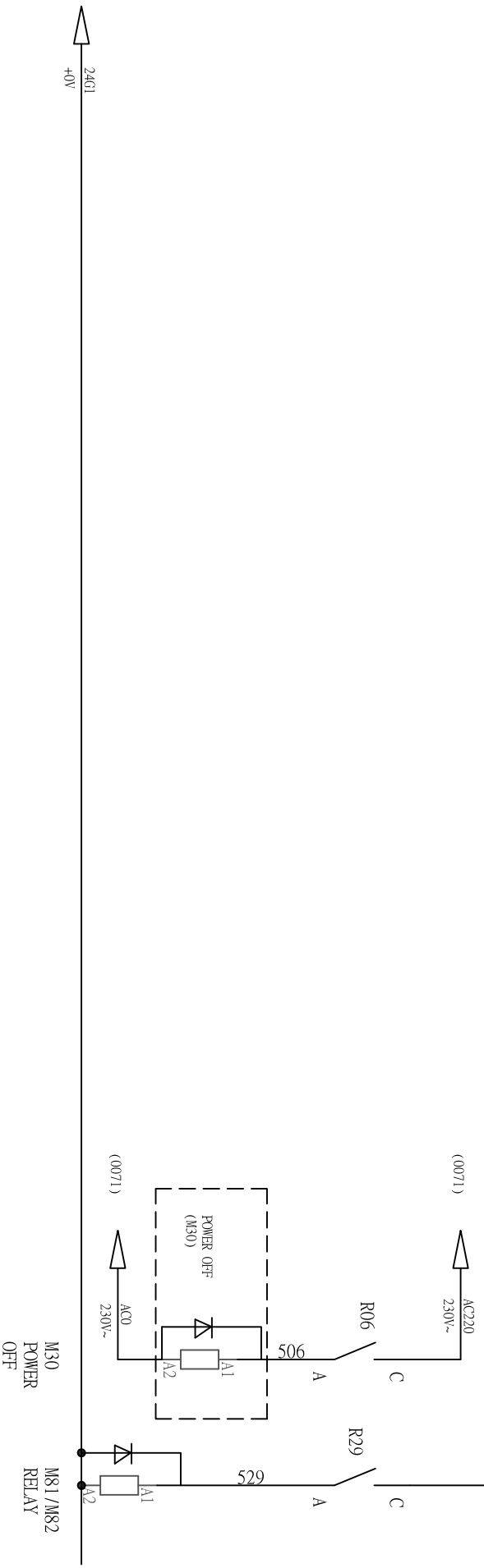
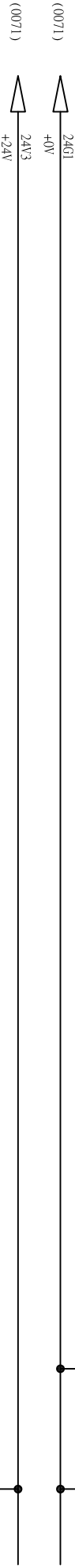

mitsubishi

DOL	DOL-A6	DOL-B6	DOL-A7	DOL-B7	DOL-A8	DOL-B8	DOL-A9	DOL-B9	DOL-A10	DOL-B10
	<Y1B>	<Y1B>	<Y1D>	<Y1D>	<Y1C>	<Y1C>	<Y1B>	<Y1B>	<Y1A>	<Y1A>

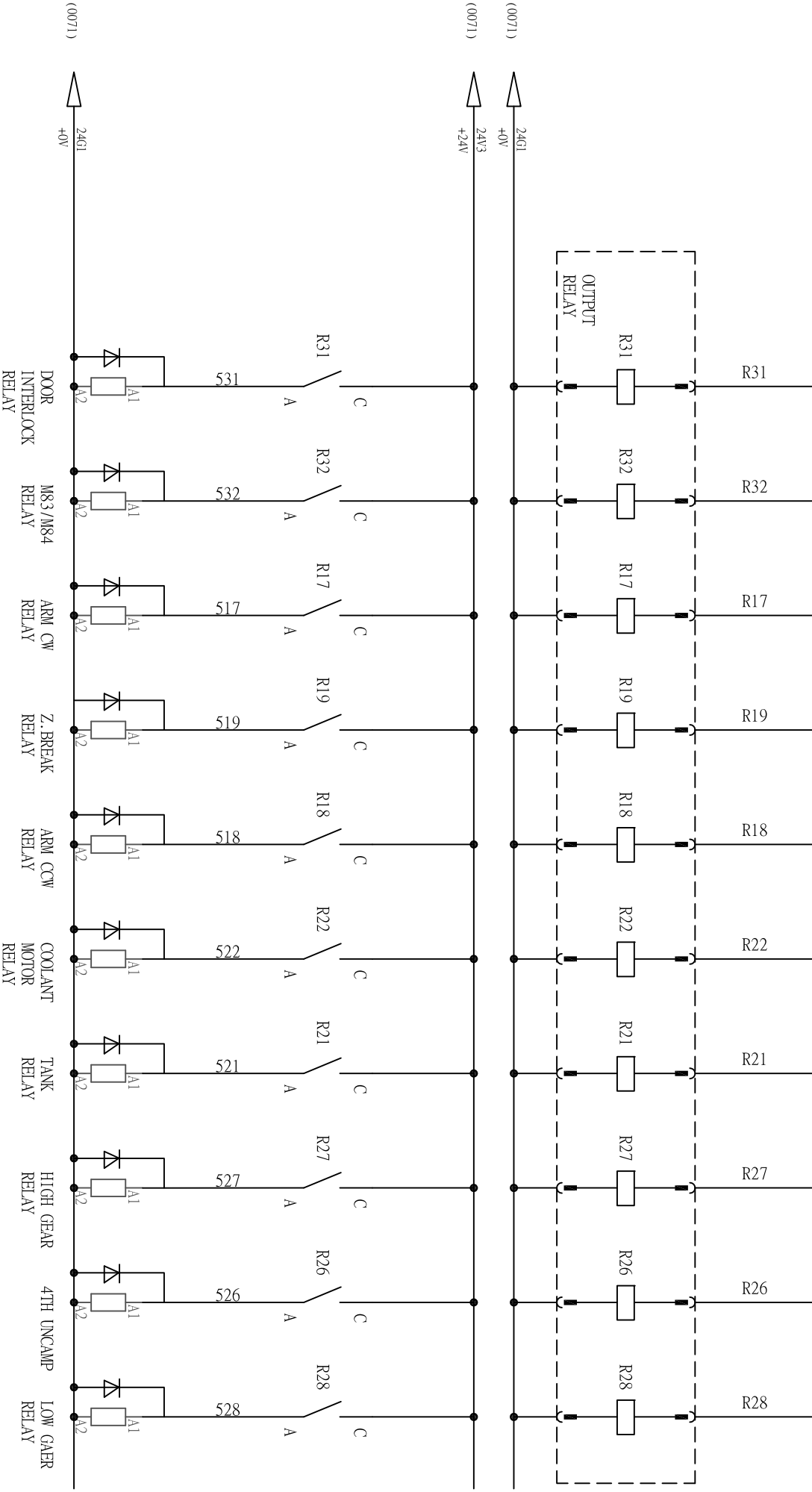

mitsubishi

mitsubishi	
DOL	DOL-A11 <Y19>
	DOL-B11 <Y9>
	DOL-A12 <Y18>
	DOL-B12 <Y8>
	DOL-A13 <Y17>
	DOL-B13 <Y7>
	DOL-A14 <Y16>
	DOL-B14 <Y6>
	DOL-A15 <Y15>
	DOL-B15 <Y5>

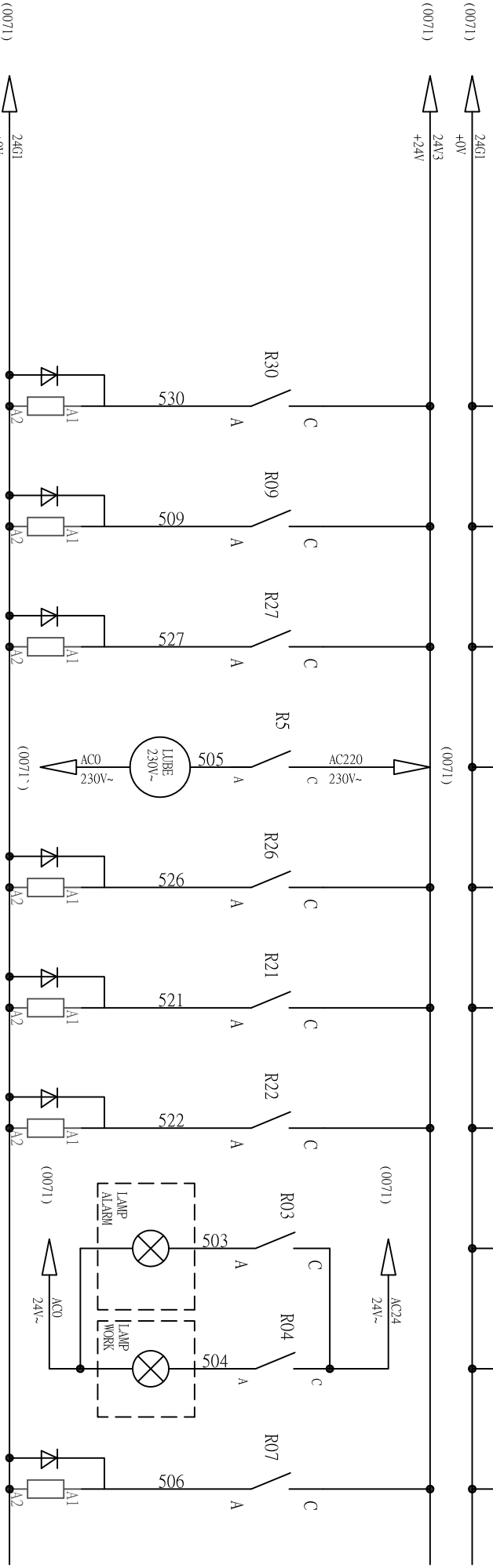
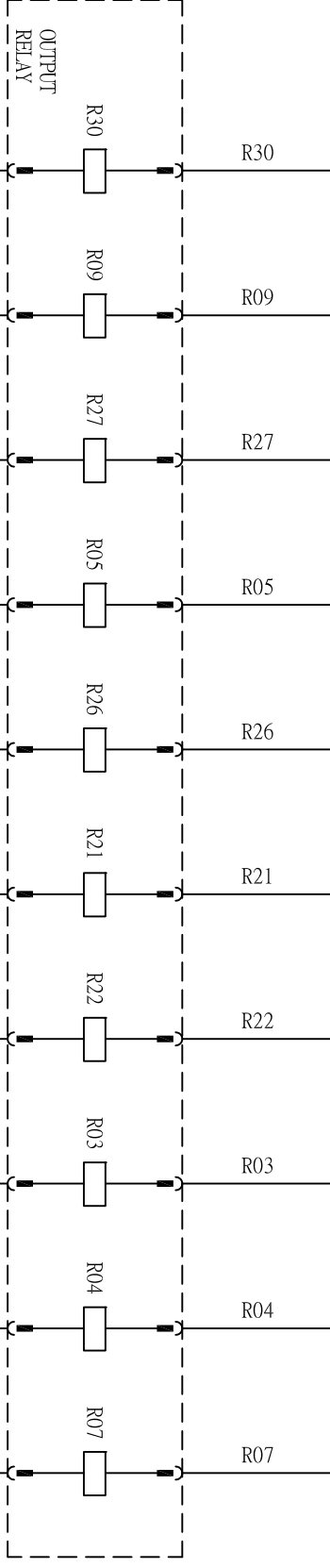

mitsubishi

DOL	DOL-A16	DOL-B16	DOL-A17	DOL-B17	DOL-A18	DOL-B18	DOL-A19	DOL-B19	DOL-A20	DOL-B20
	<Y14>	<Y4>	<Y13>	<Y3>	<Y12>	<Y2>	<Y11>	<Y1>	<Y10>	<Y0>

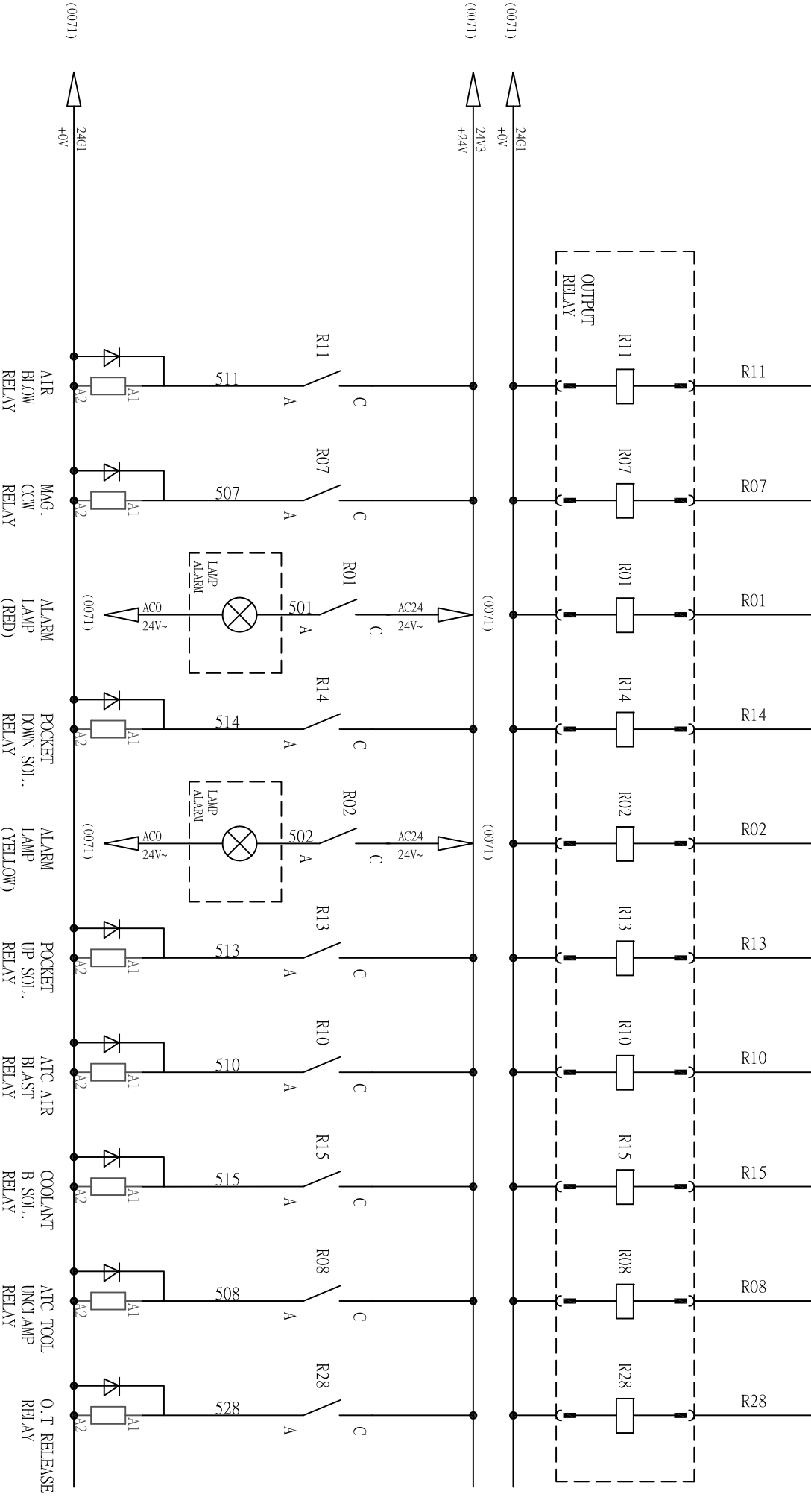

(0071) 24V1
+24V

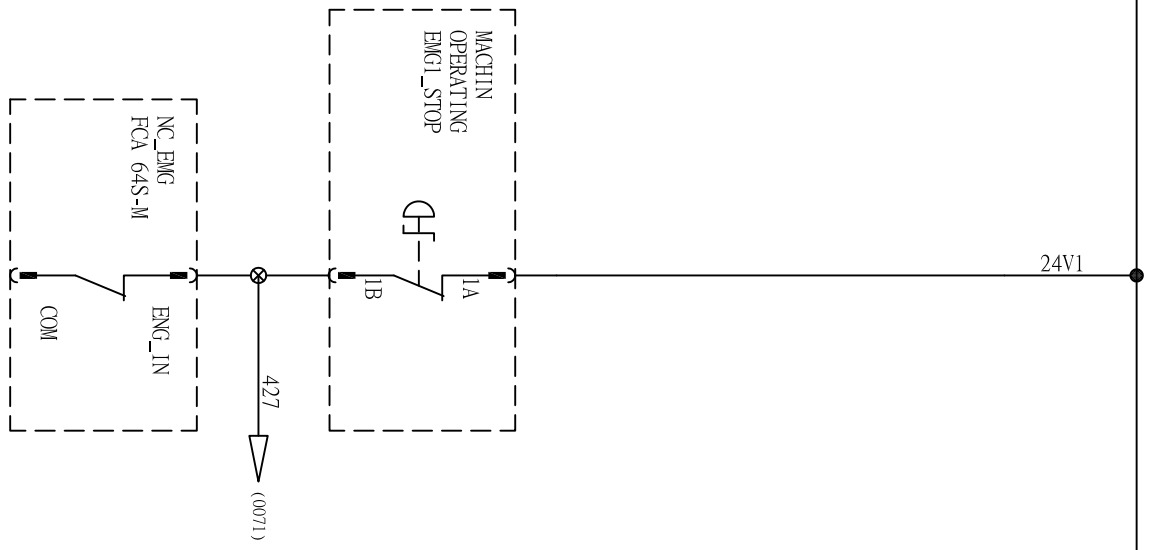

TITLE: GENERAL SECURITY MODULE 1

<EMG STOP >



DESIGNER	CONTROL	MACHINE	PAGE	VER
2014/02/14	MITSUBISHI		0040	A

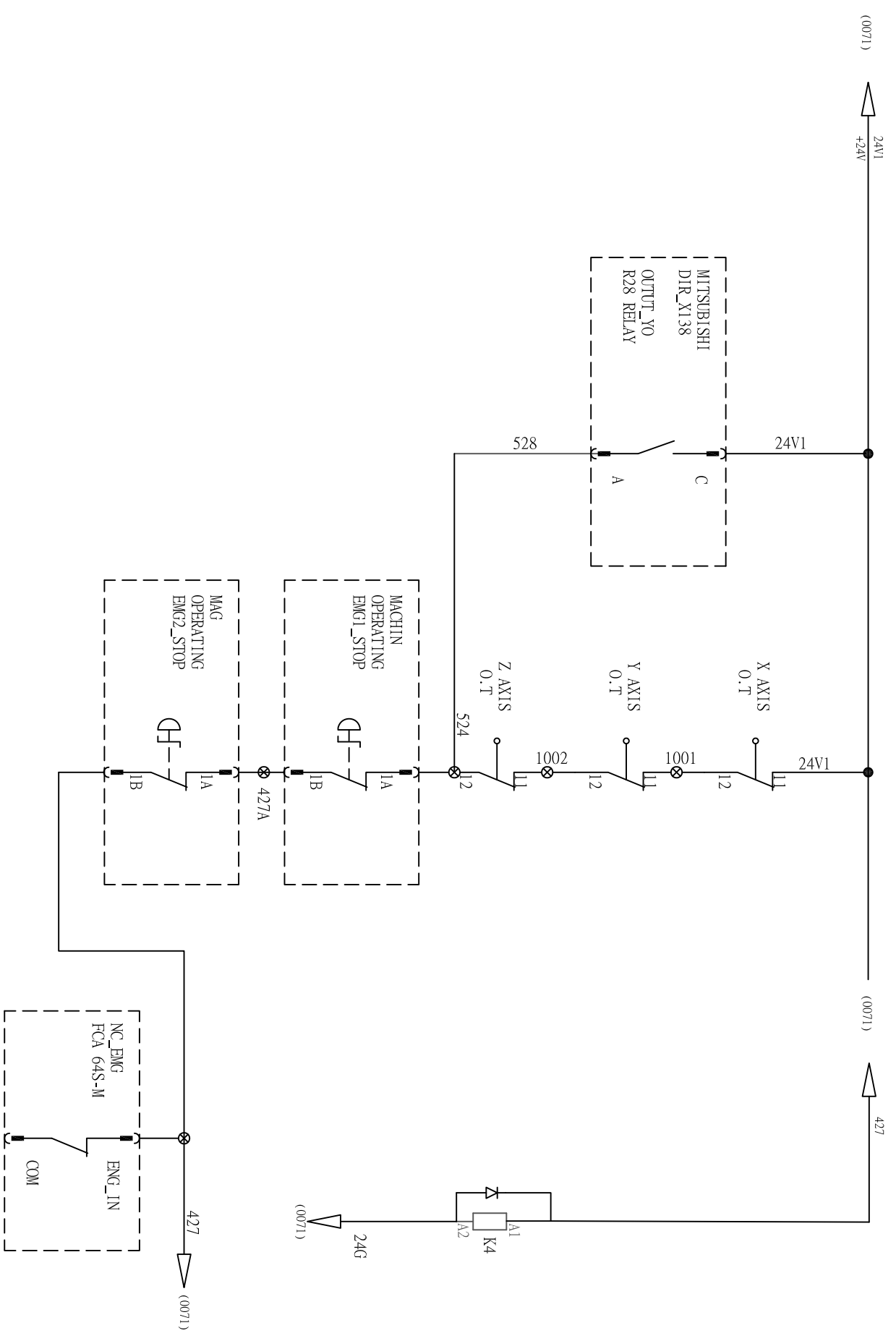

TITLE: GENERAL SECURITY MODULE 1 FOR LX1610-2210
 <AIXS O.T AND O.T RELEASE >



DESIGNER	CONTROL	MACHINE	PAGE	VER
2014/02/14	MITSUBISHI		0040-1	A

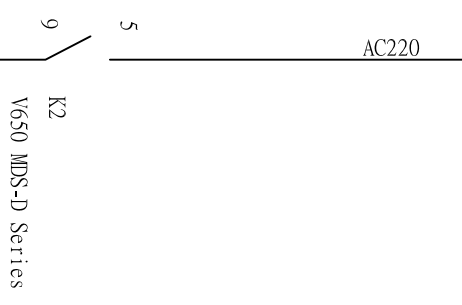
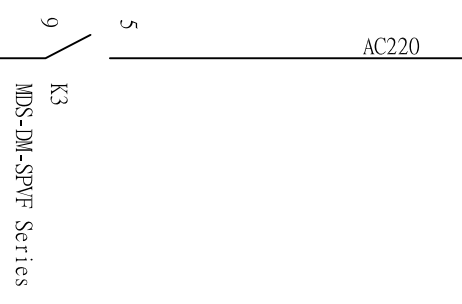
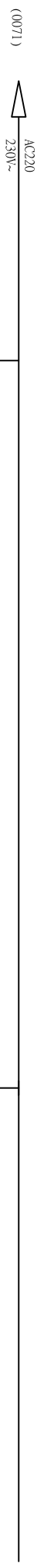

TITLE: GENERAL SECURITY MODULE 2



DESIGNER	CONTROL	MACHINE	PAGE	VER
2014/02/14	MITSUBISHI		0041	A

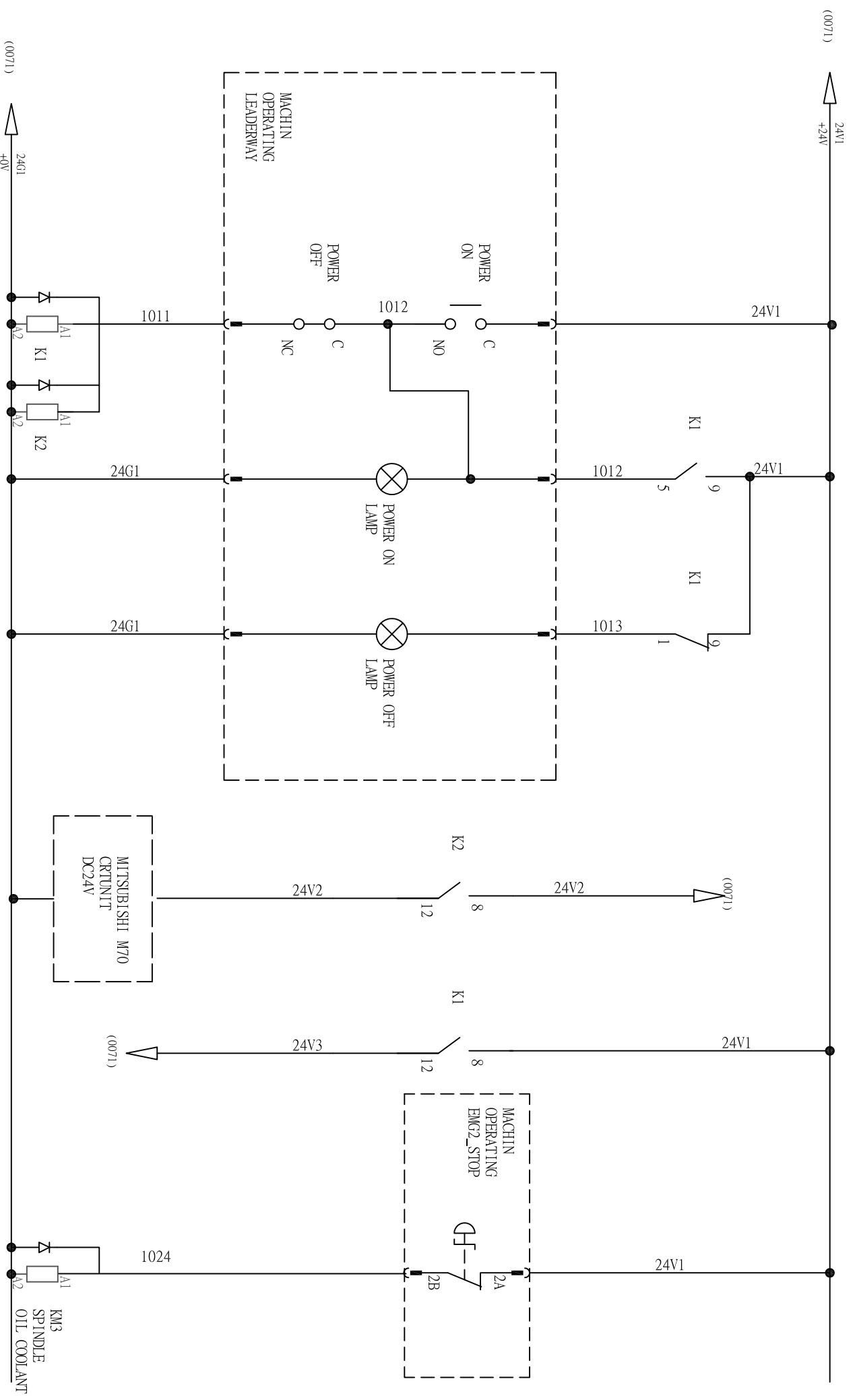

TITLE: GENERAL SECURITY MODULE 3		LEADERWAY		DESIGNER	CONTROL	MACHINE	PAGE	VER
<POWER ON & OFF >				2014/02/14	MITSUBISHI		0042	A

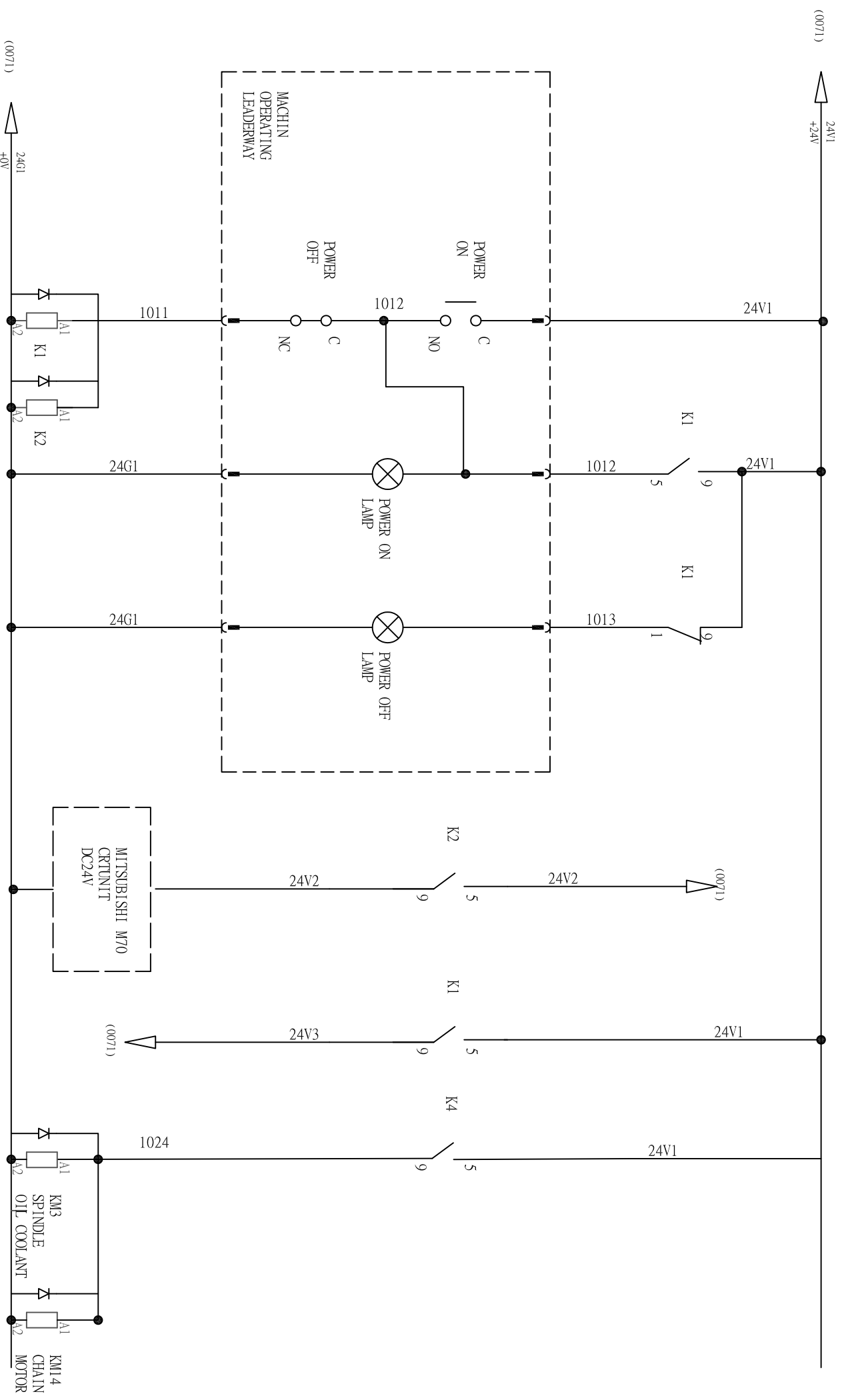

TITLE: GENERAL SECURITY MODULE 4
 <POWER ON & OFF > <FOR LX1610-2210>

LEADERWAY

DESIGNER	CONTROL	MACHINE	PAGE	VER
2014/02/14	MITSUBISHI		0043	A

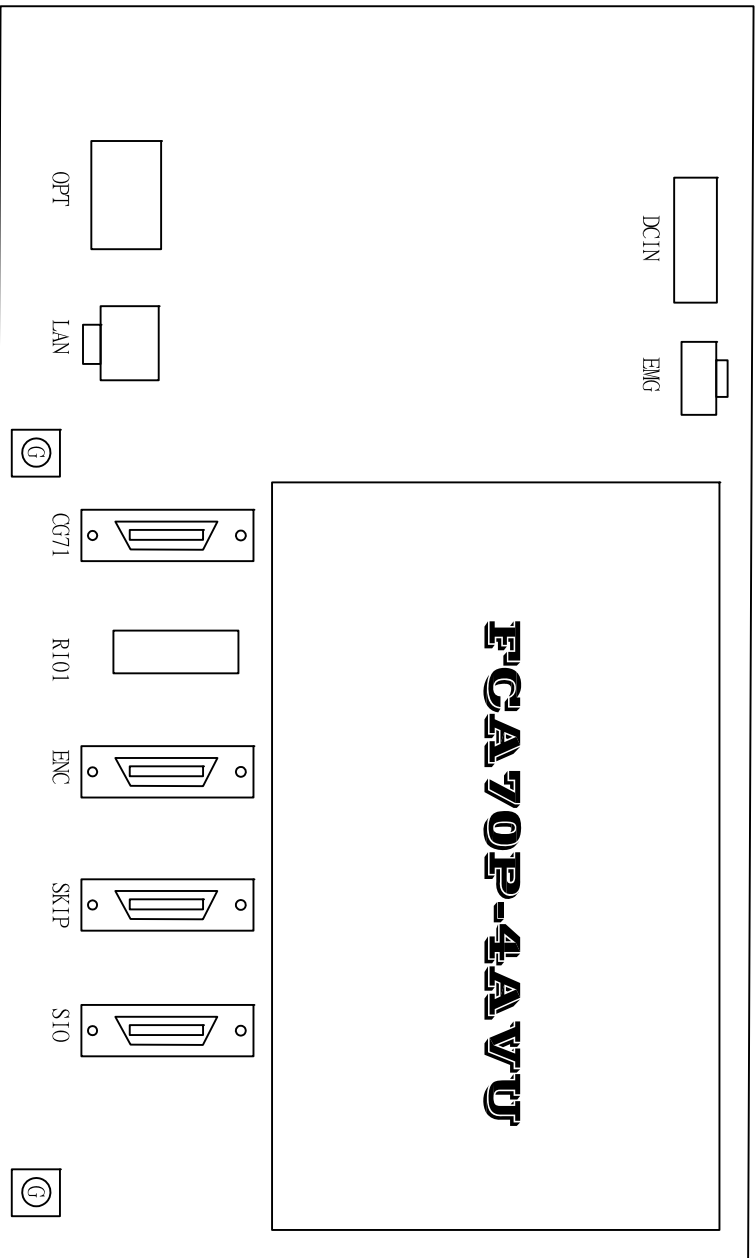
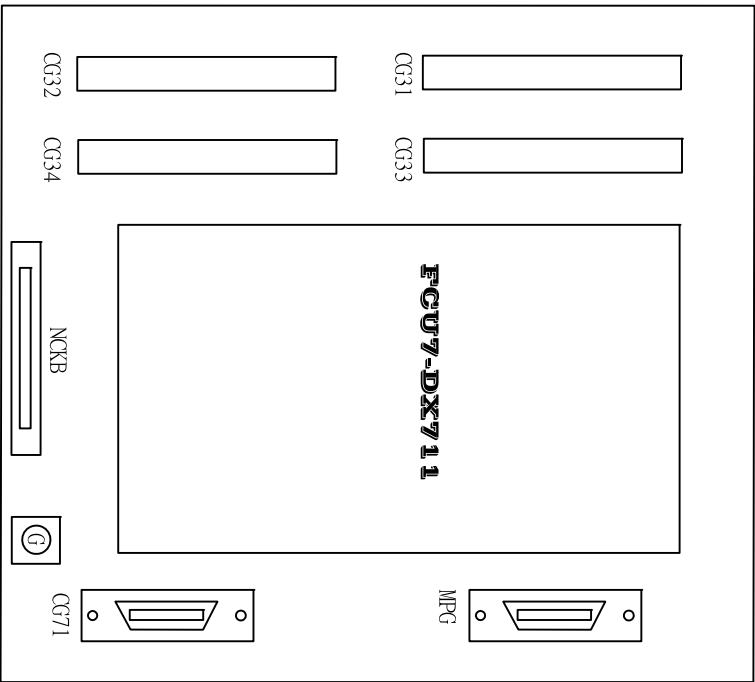

TITLE: CNC - M70

LEADERWAY

DESIGNER	CONTROL	MACHINE	PAGE	VER
2014/02/14	MITSUBISHI		0044	A

MDS-DM-SPV Series

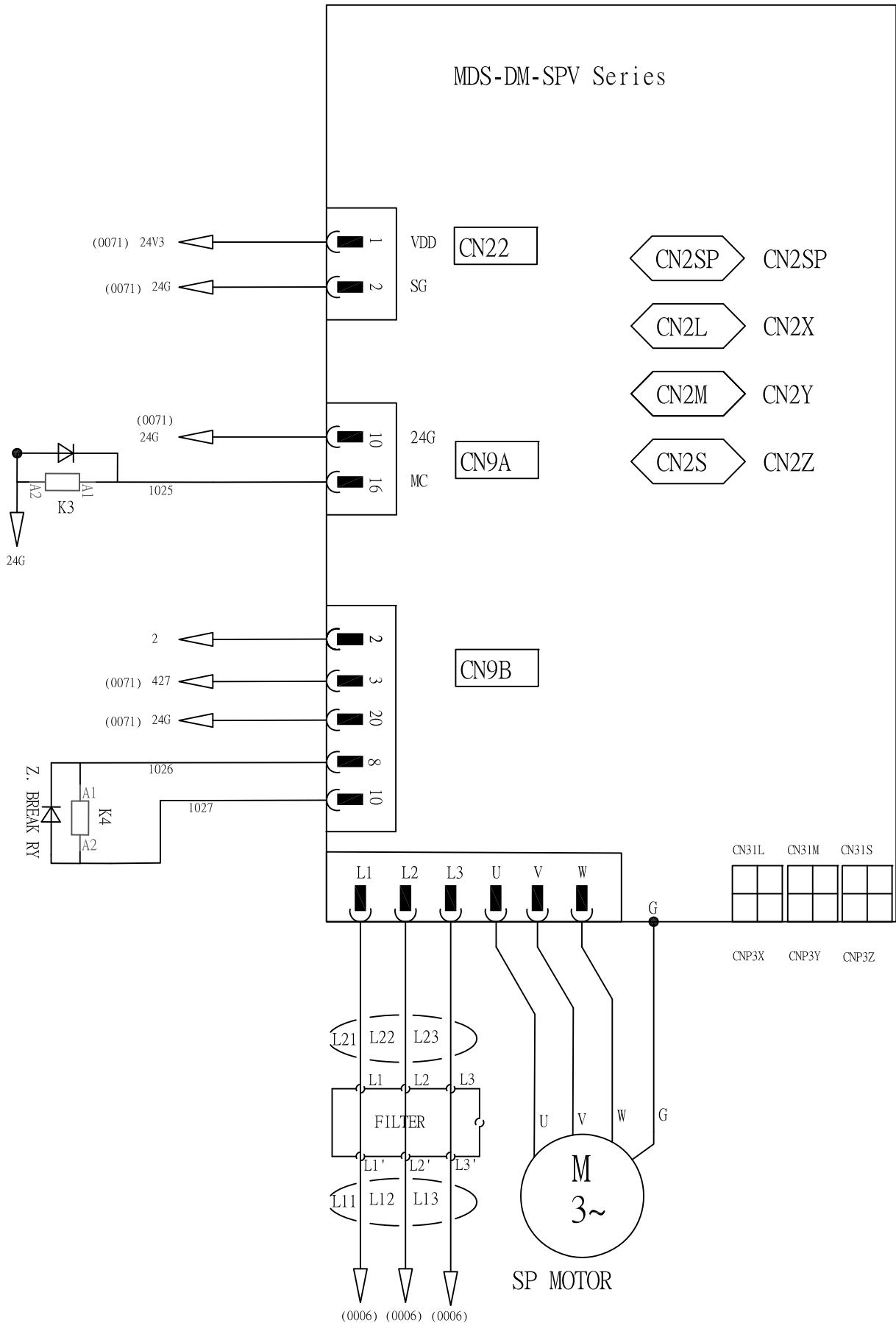

TITLE: MDS-DM-SPVF Series

LEADERWAY

DESIGNER

CONTROL

MACHINE

PAGE

VER

2014/02/14

mitsubishi

0045

A

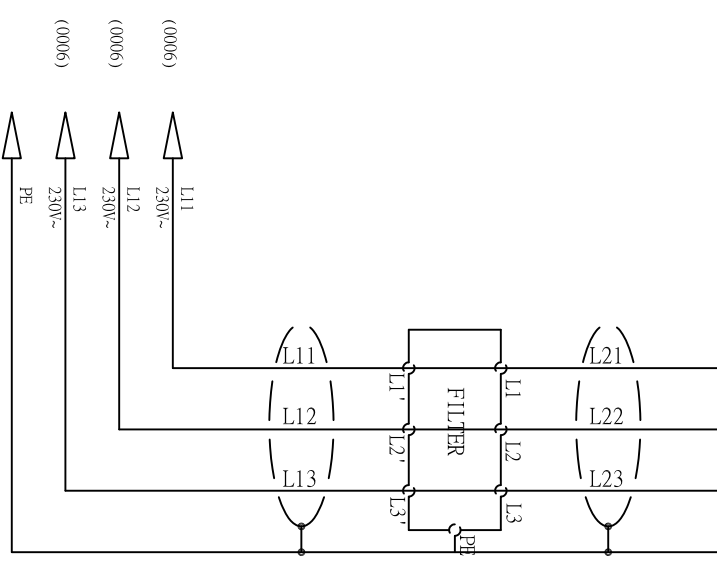
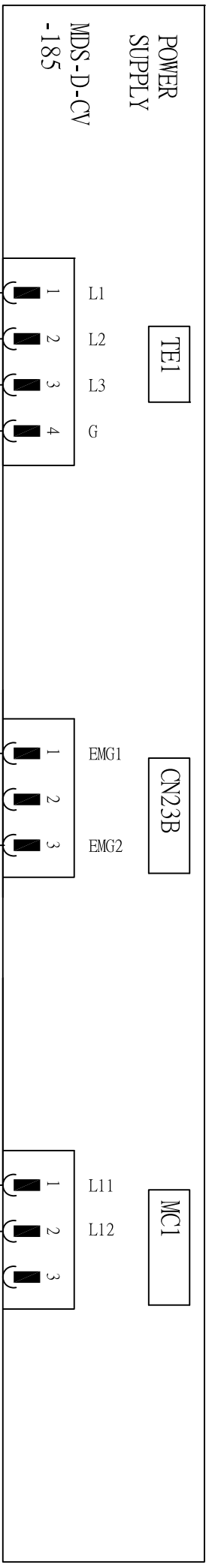

1023/
K100A1
(0041)

AC220
K2
(0071)

3L1
(0071)

3L2
(0071)

TITLE: POWER SUPPLY

LEADERWAY

DESIGNER	CONTROL	MACHINE	PAGE	VER
2014/02/14	MITSUBISHI		0046	A

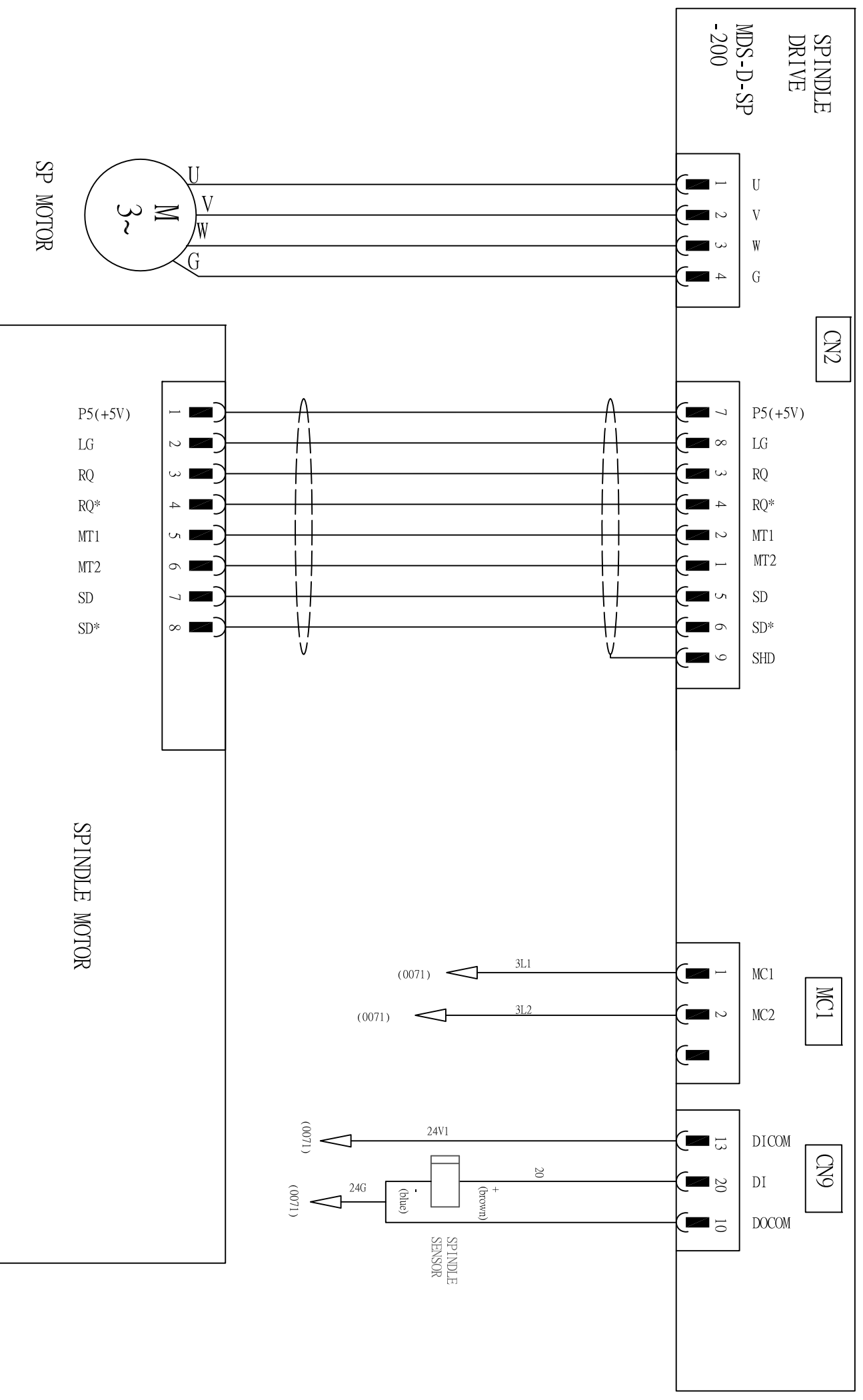

TITLE: SPINDLE DRIVER AXIS

LEADERWAY

DESIGNER	CONTROL	MACHINE	PAGE	VER
2014/02/14	MITSUBISHI		0047	A

SPINDLE DRIVE

MDS-D-SP-200/320

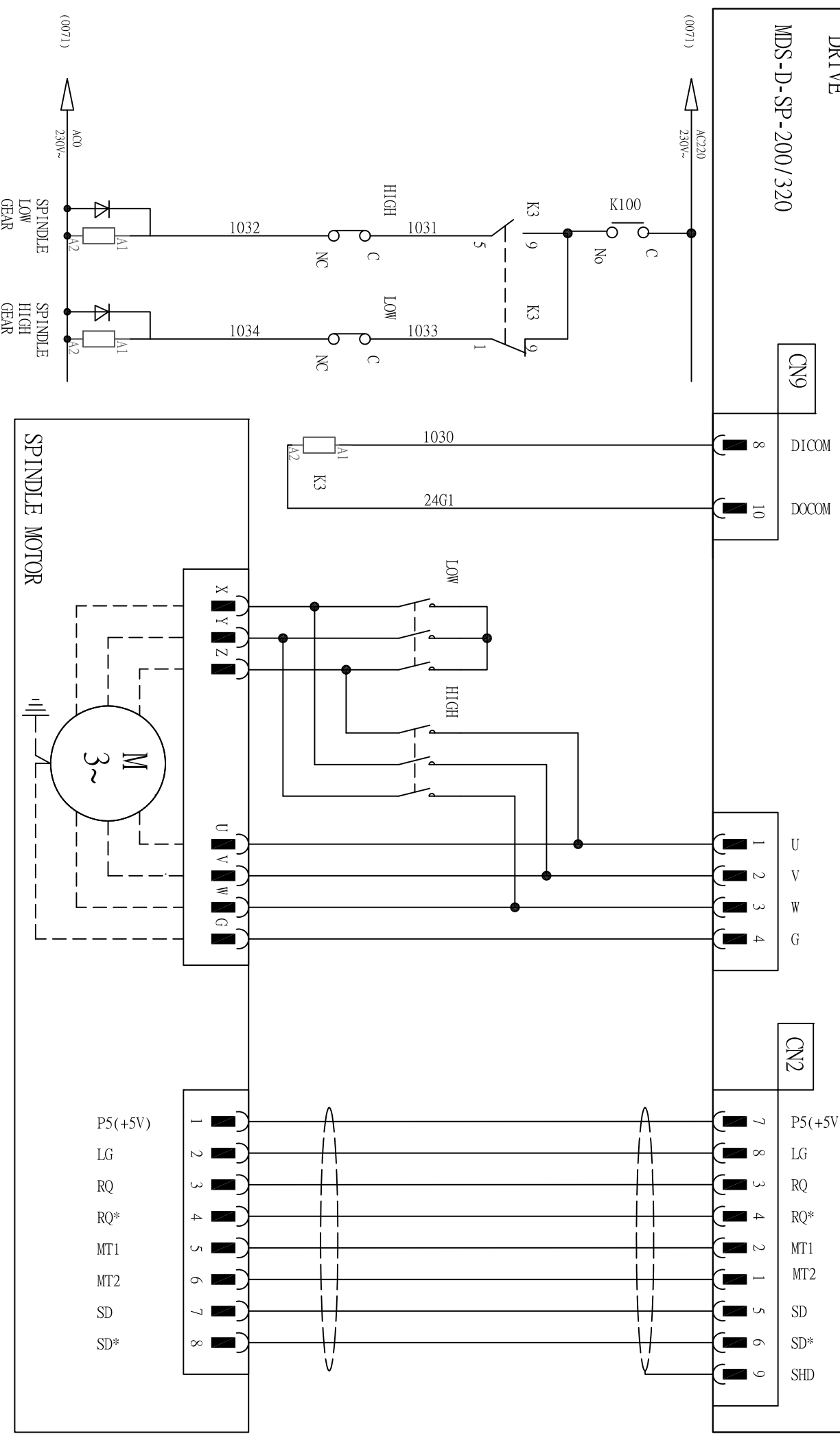

TITLE: SPINDLE DRIVER AXIS

LEADERWAY

DESIGNER	CONTROL	MACHINE	PAGE	VER
2014/02/14	MITSUBISHI		0048	A

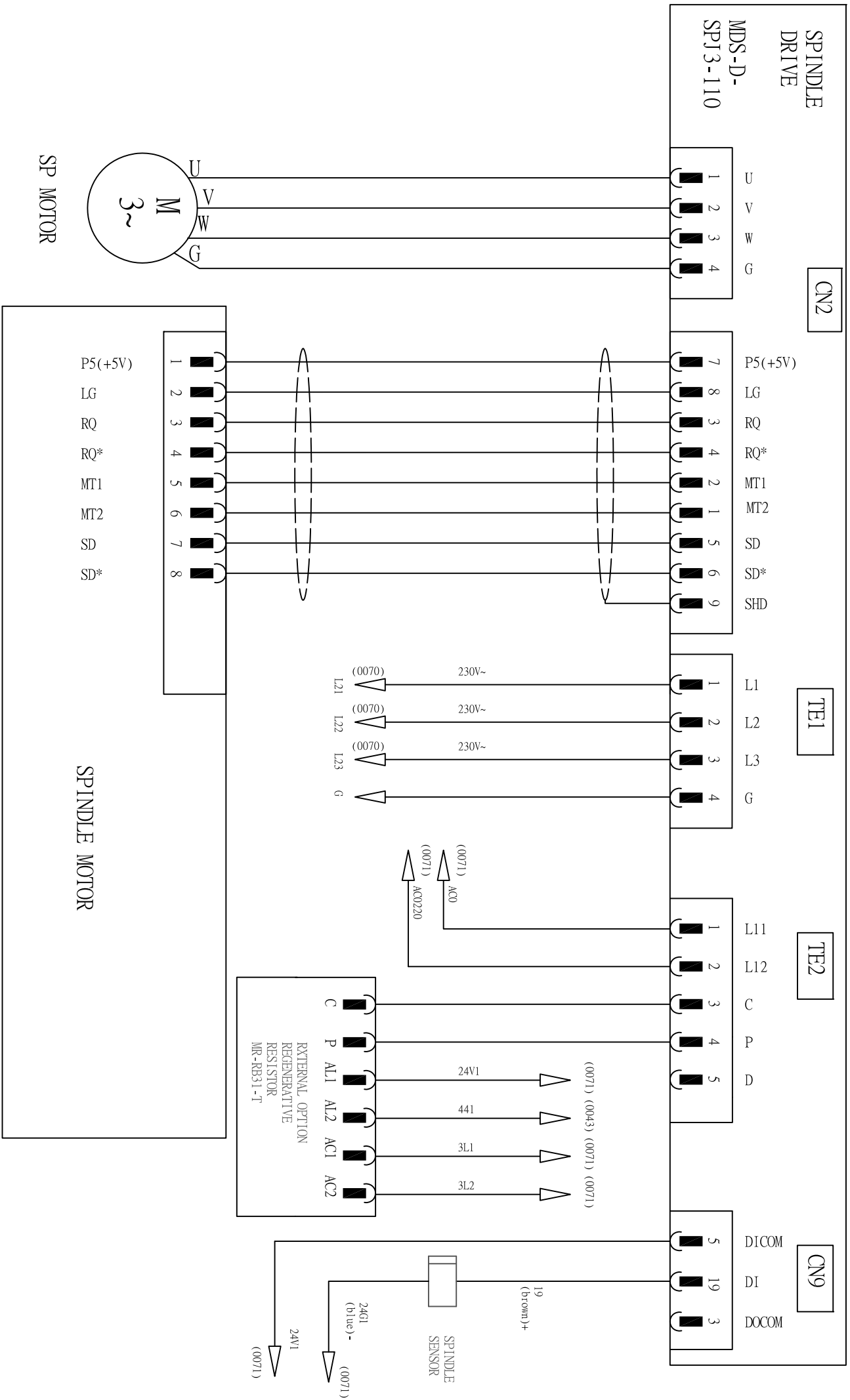

TITLE: SPINDLE DRIVER AXIS

LEADERWAY

DESIGNER	CONTROL	MACHINE	PAGE	VER
2014/02/14	MITSUBISHI		0049	A

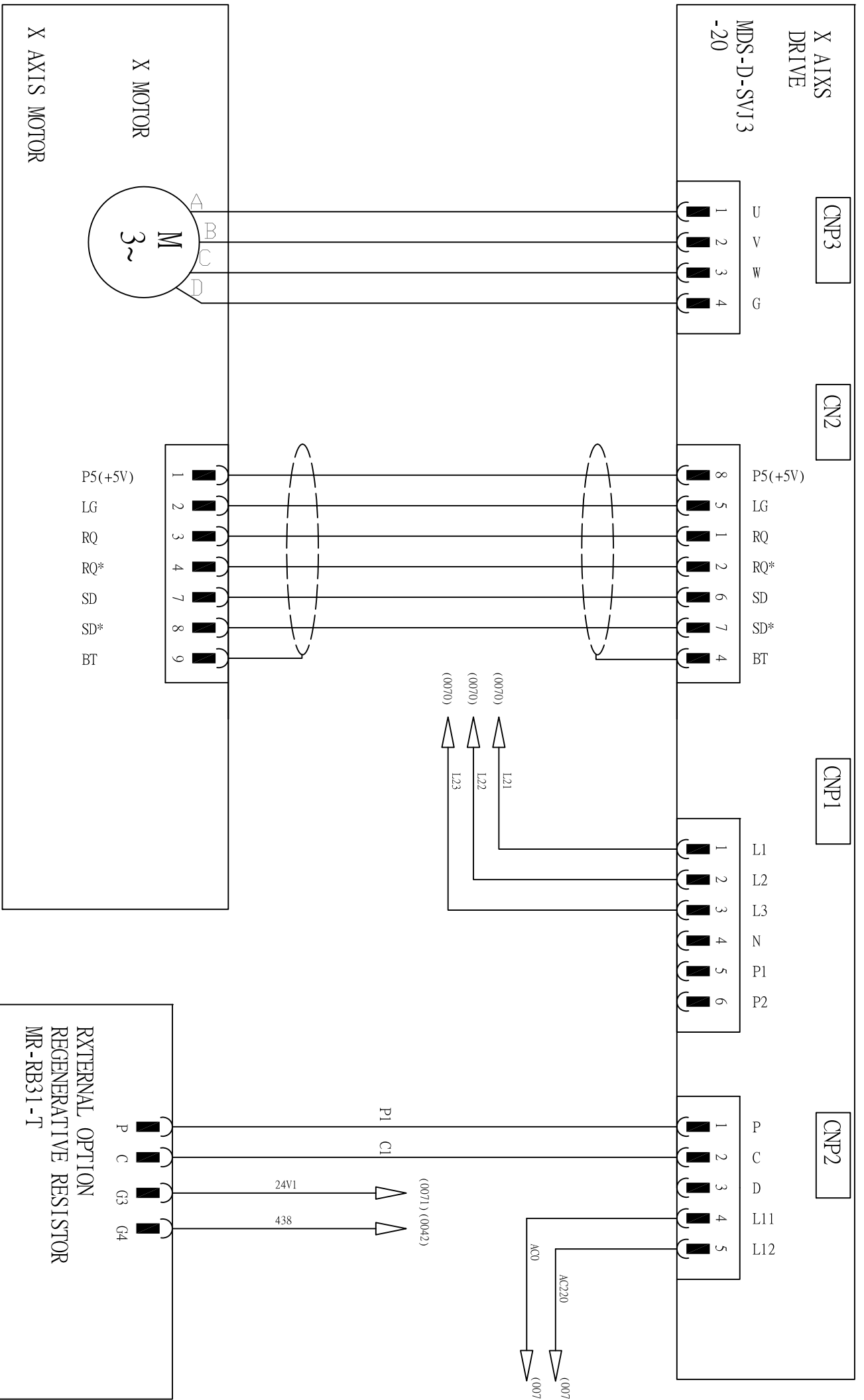

TITLE: AXIS SERVO DRIVES X



DESIGNER	CONTROL	MACHINE	PAGE	VER
2014/02/14	MITSUBISHI		0050	A

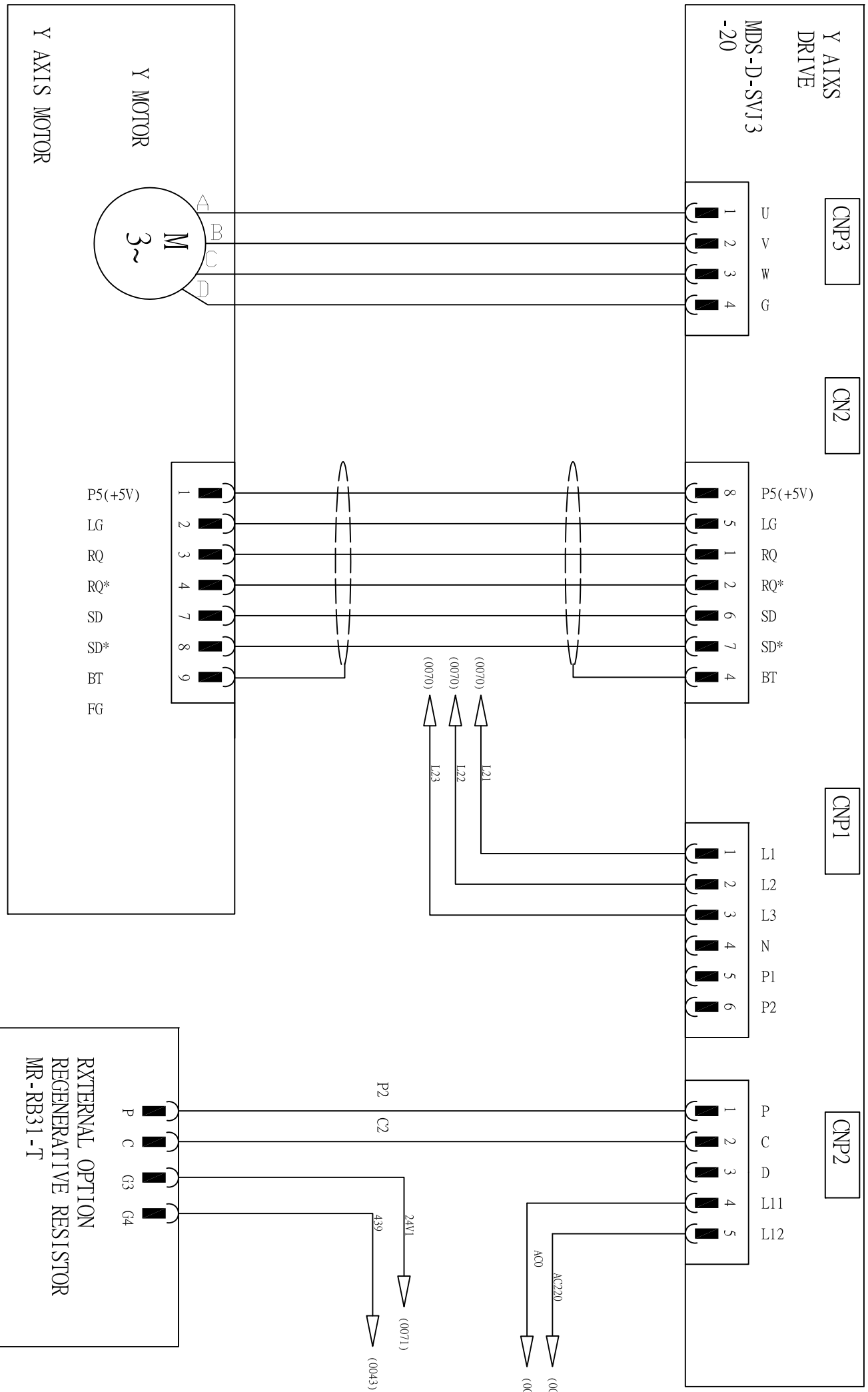

TITLE: AXIS SERVO DRIVES Y

LEADERWAY

DESIGNER	CONTROL	MACHINE	PAGE	VER
2014/02/14	MITSUBISHI		0051	A

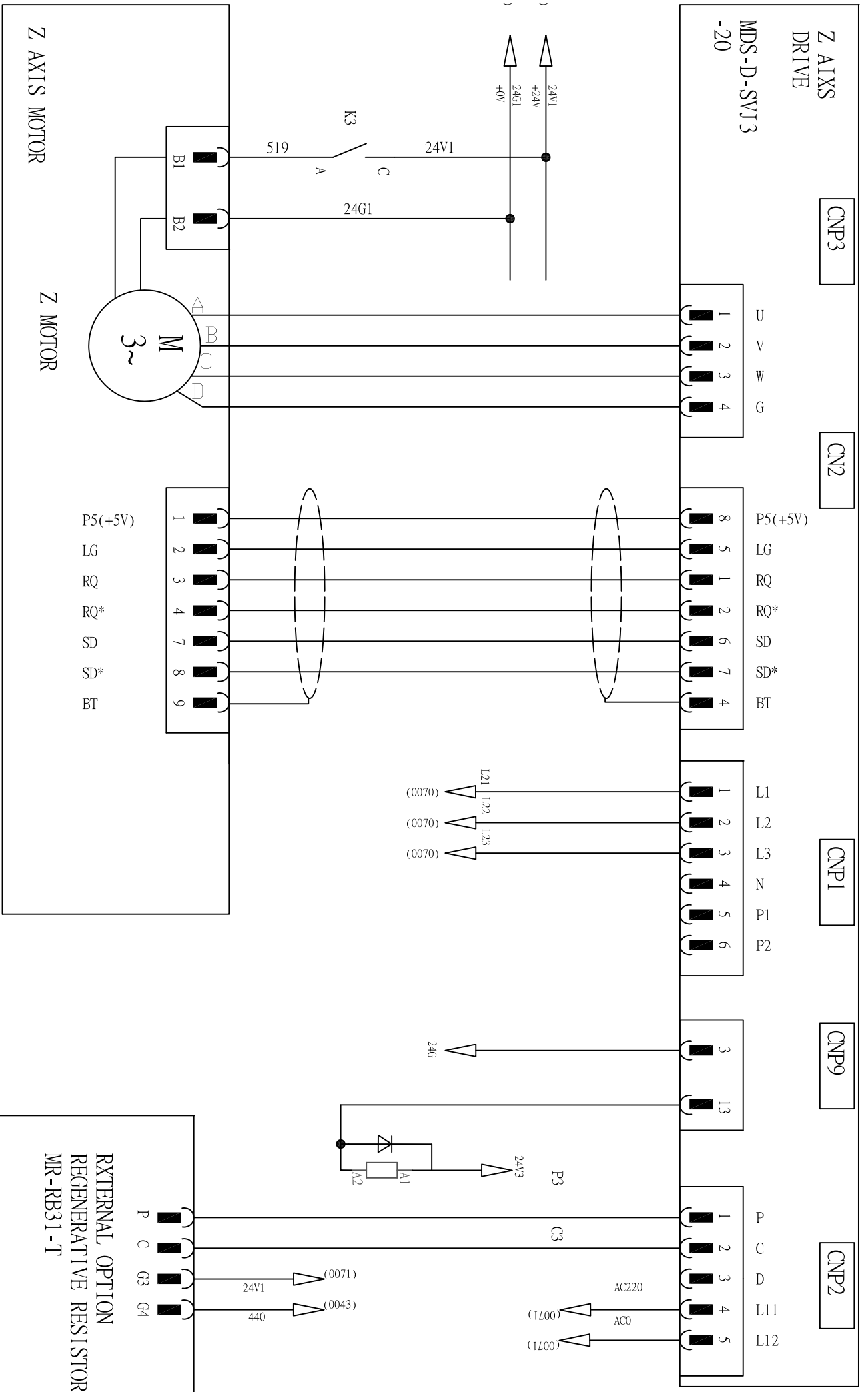

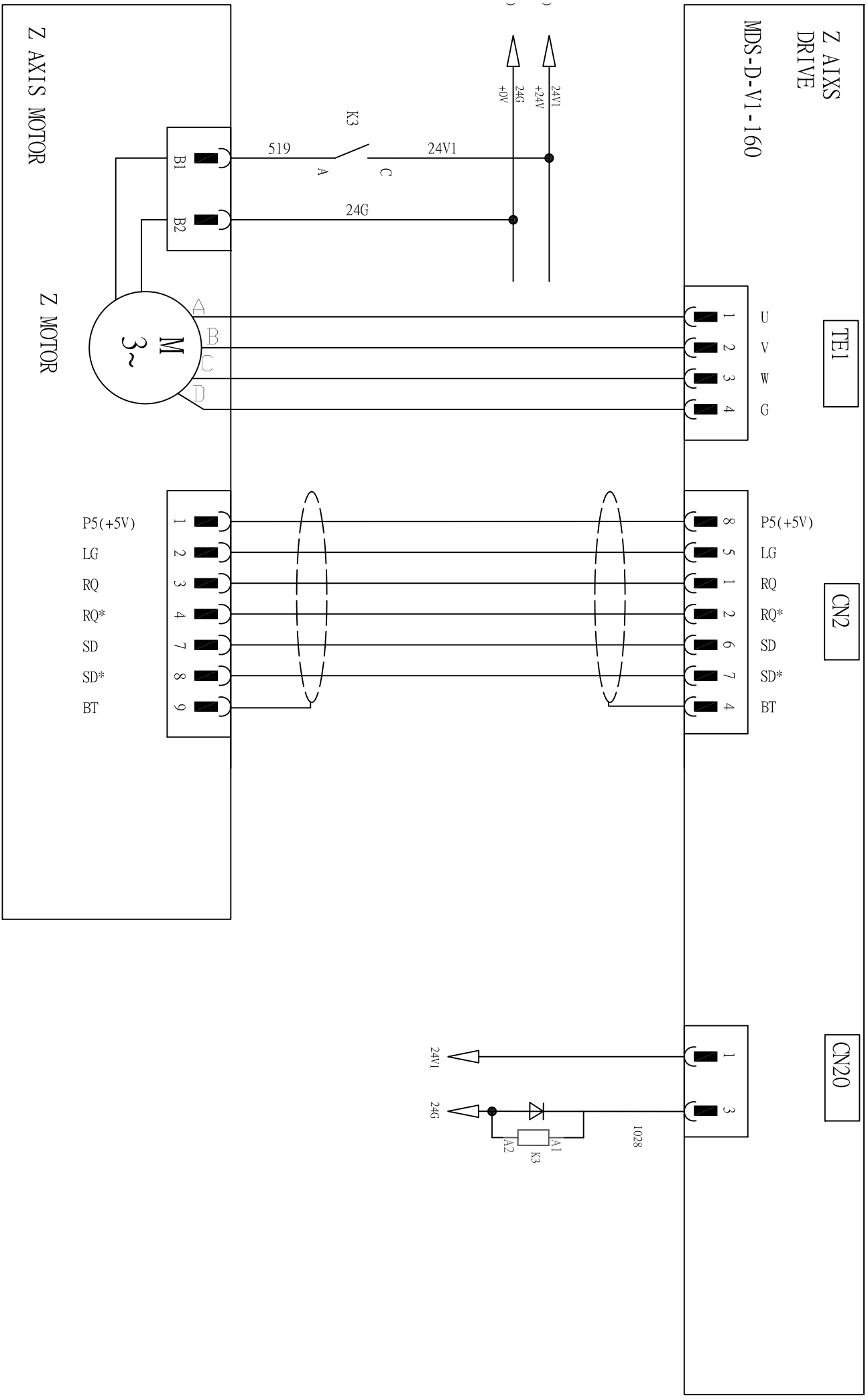

TITLE: AXIS SERVO DRIVES Z

LEADERWAY

DESIGNER	CONTROL	MACHINE	PAGE	VER
2014/02/14	MITSUBISHI		0052-1	A

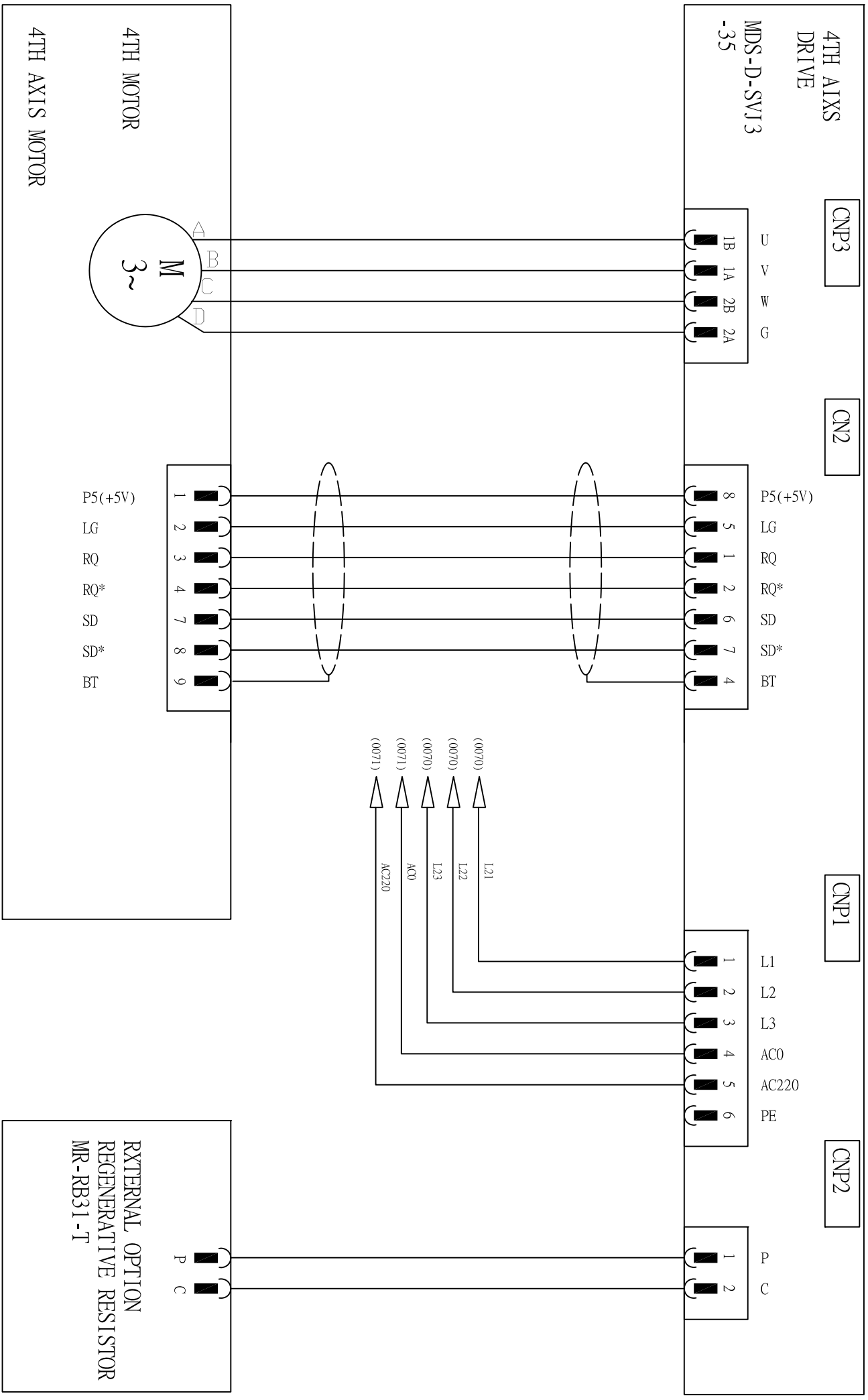

TITLE: AXIS SERVO DRIVES 4TH

LEADERWAY

DESIGNER	CONTROL	MACHINE	PAGE	VER
2014/02/14	MITSUBISHI		0053	A

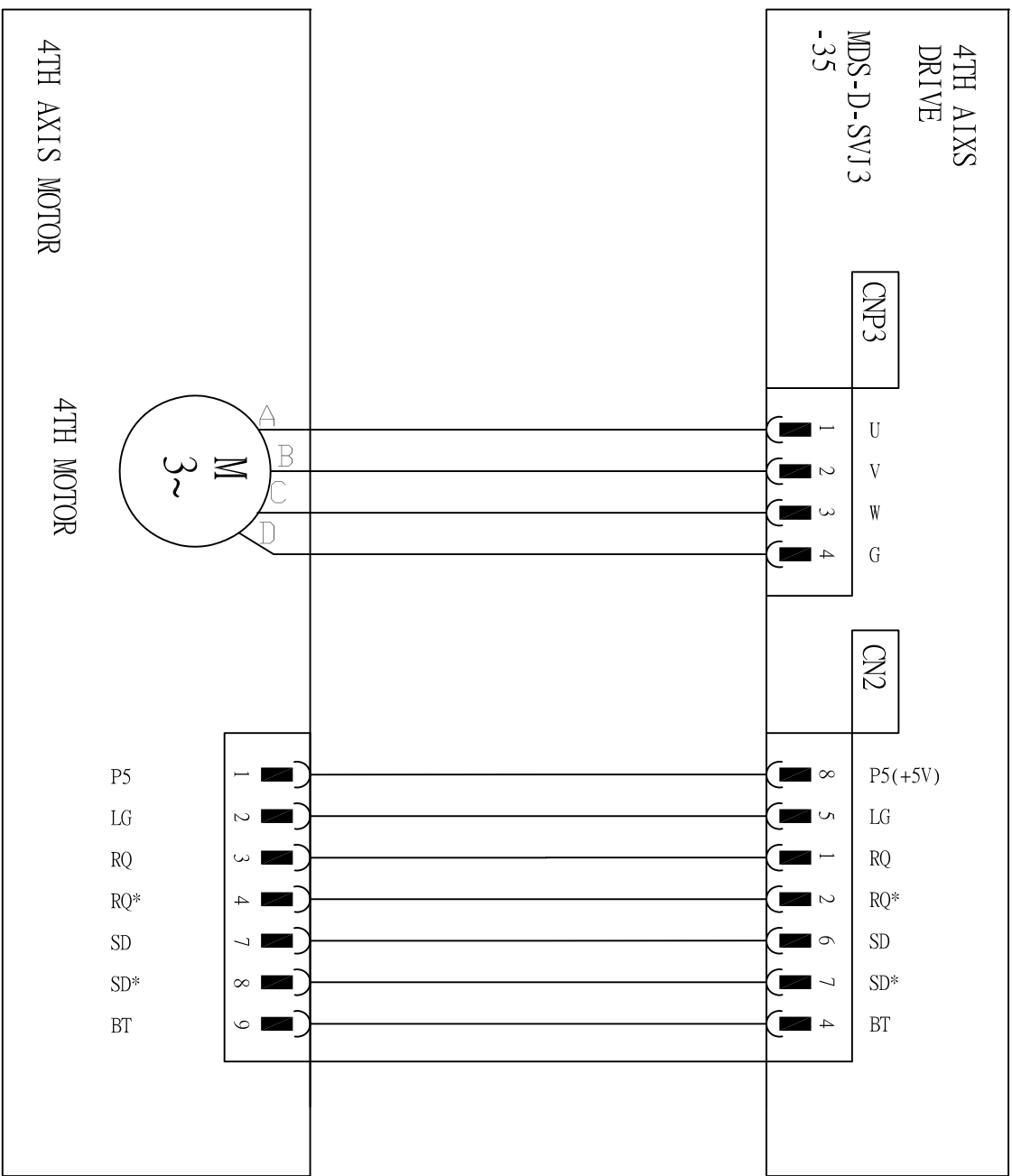
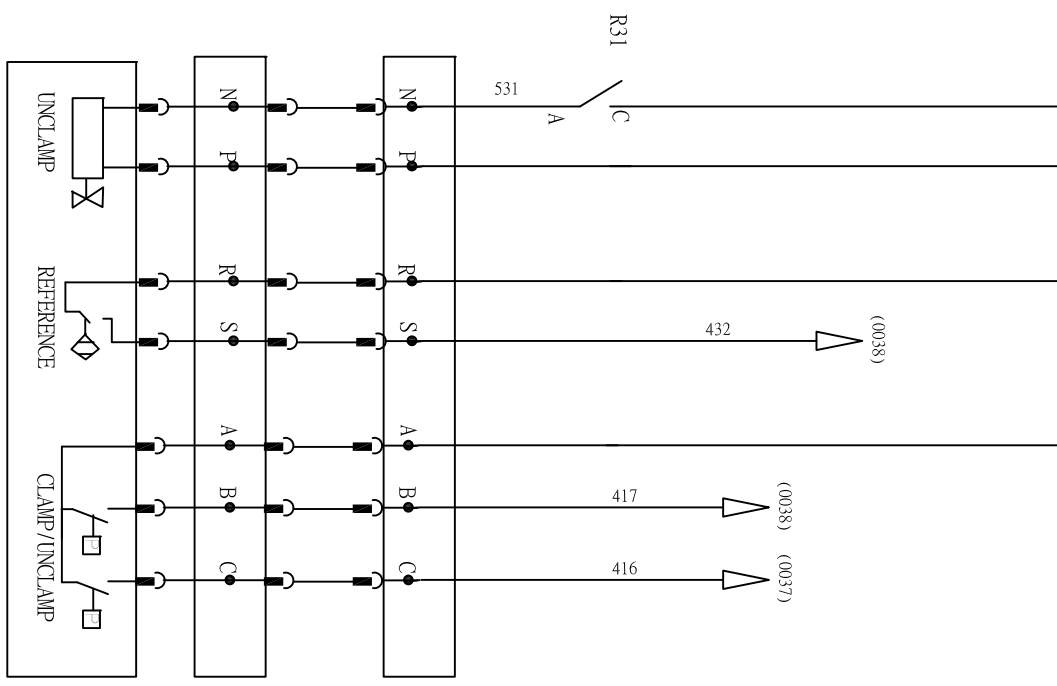
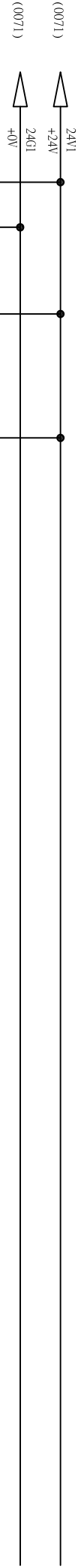

TITLE: FEED DRIVER 4TH AXIS (OPTION)

LEADERWAY

DESIGNER	CONTROL	MACHINE	PAGE	VER
2014/02/14	MITSUBISHI		0054	A

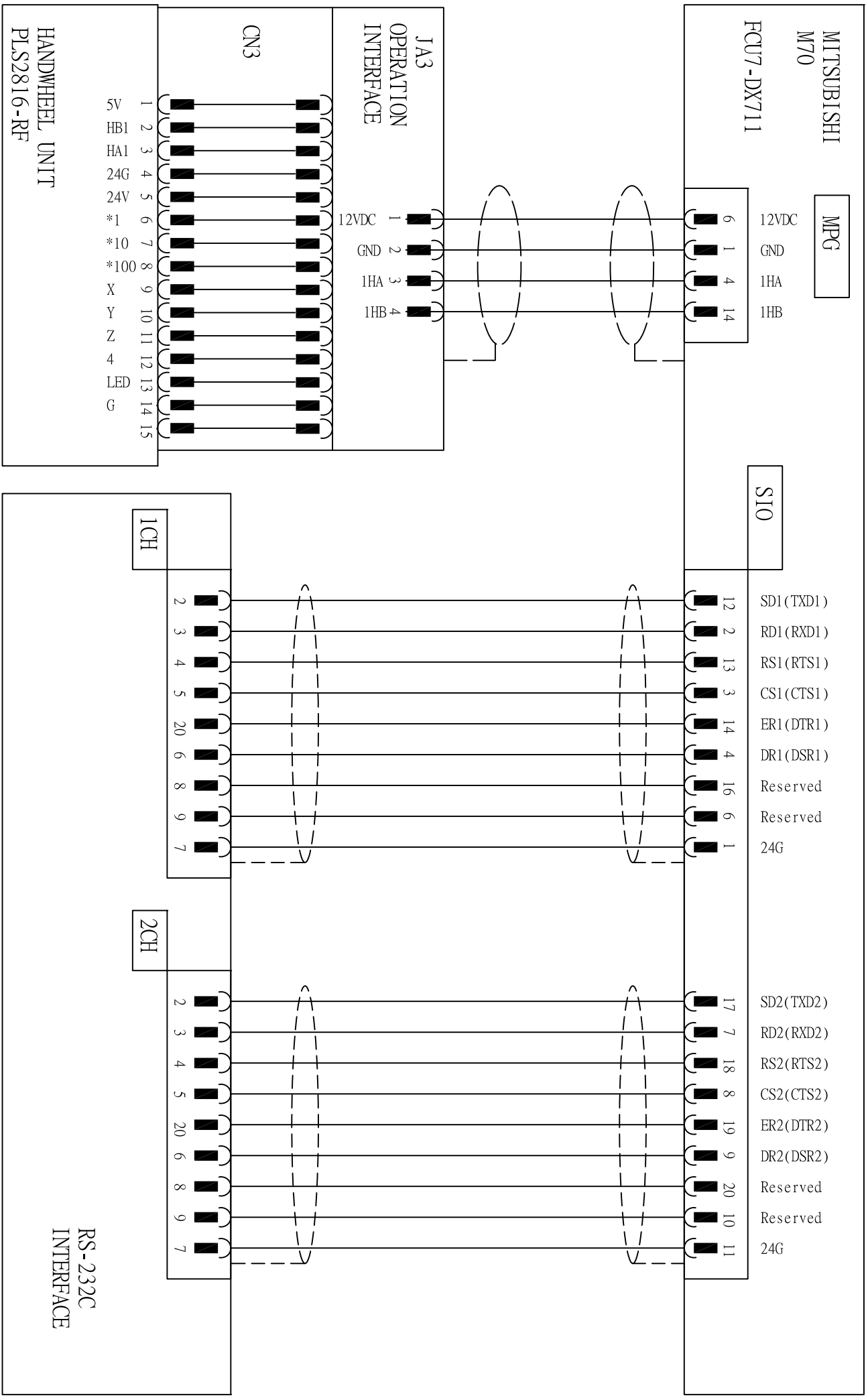

TITLE: HANDWHEEL AND RS-232C-M70A

LEADERWAY

DESIGNER	CONTROL	MACHINE	PAGE	VER
2014/02/14	MITSUBISHI M70		0055	A

LEADERWAY
MACHINE OPERATION INTERFACE

D-SUB-15D

CN3

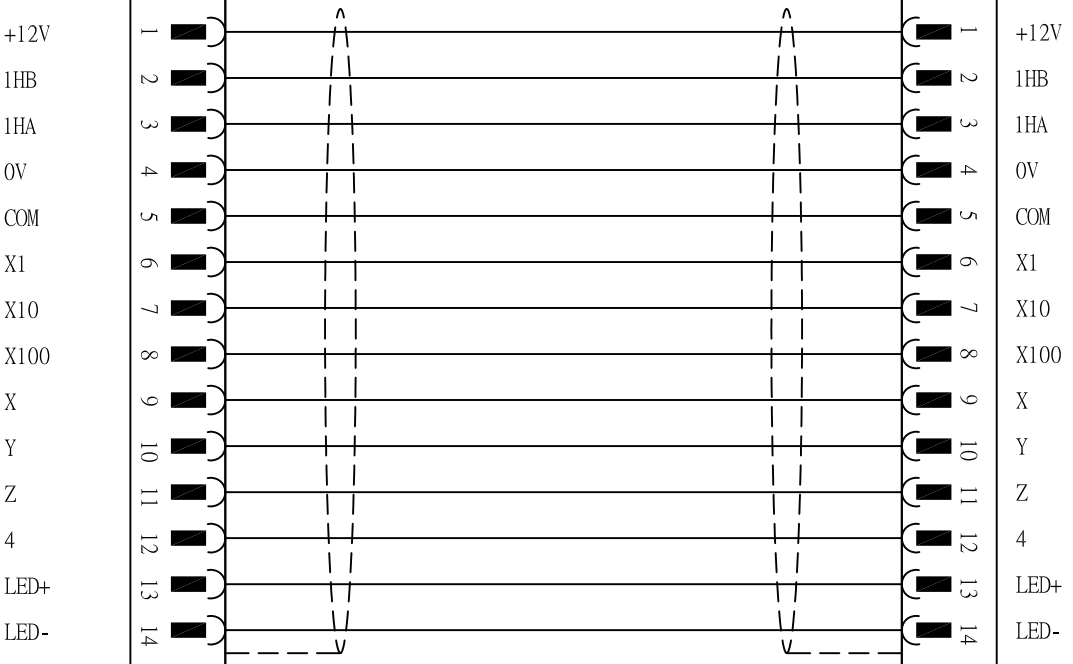

HANDWHEEL UNIT

PLS2816-RF

TITLE: HANDWHEEL LINK UNIT

LEADERWAY

DESIGNER	CONTROL	MACHINE	PAGE	VER
2014/02/14	MITSUBISHI		0056	A

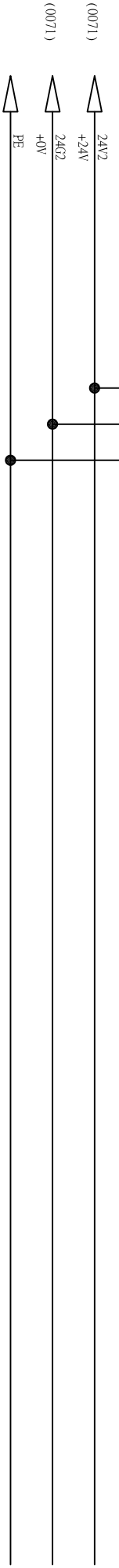
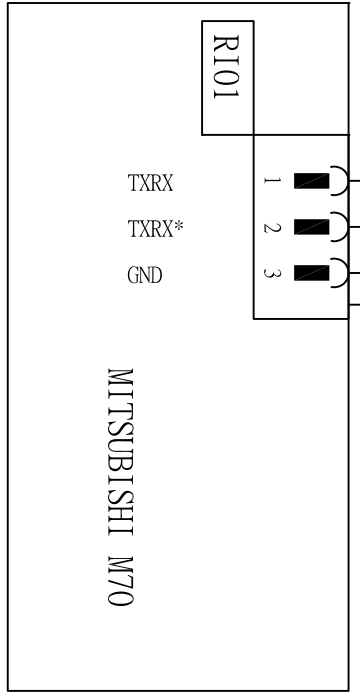
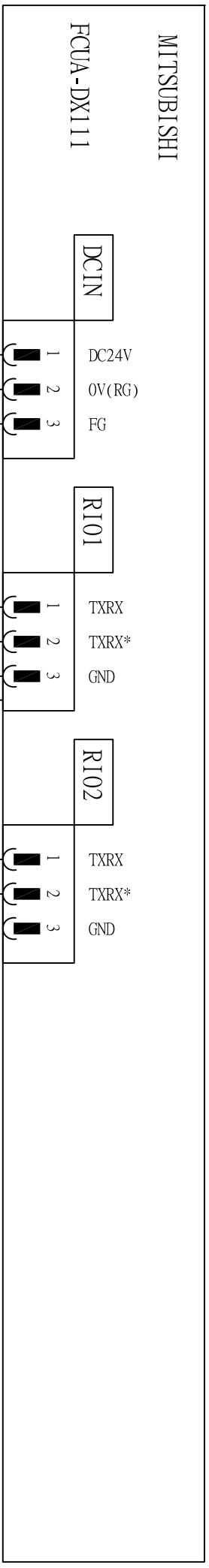

TITLE: REMOTE I/O CONTROL LINK UNIT

LEADERWAY

DESIGNER	CONTROL	MACHINE	PAGE	VER
2014/02/14	MITSUBISHI		0057	A

TB1

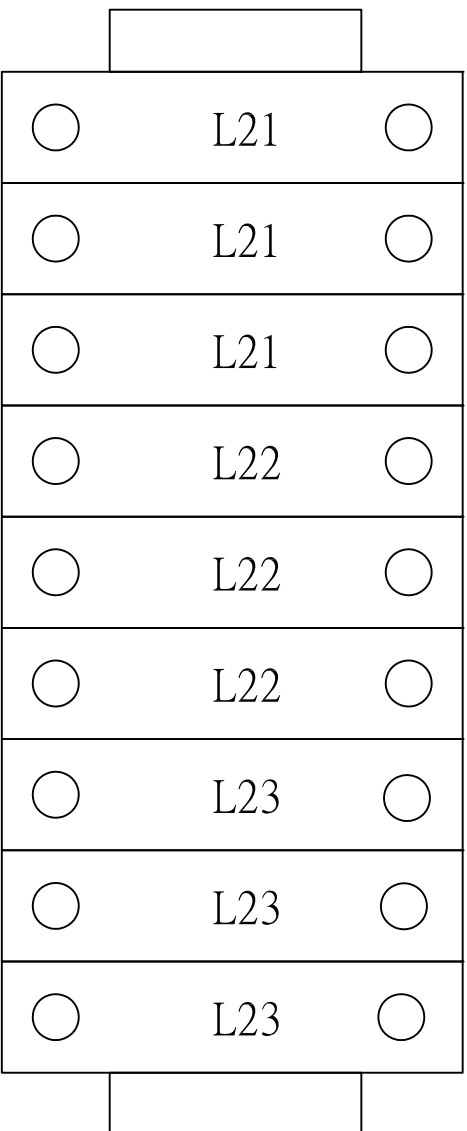

TITLE: TB1 LAYOUT



DESIGNER	CONTROL	MACHINE	PAGE	VER
2014/02/14	MITSUBISHI		0070	A

TB2

○ ○	3L1	○
○ ○	3L1	○
○ ○	3L2	○
○ ○	3L2	○
○ ○	3L3	○
○ ○	3L3	○
○ ○	AC220	○
○ ○	AC220	○
○ ○	AC220	○
○ ○	AC0	○
○ ○	AC0	○
○ ○	AC0	○
○ ○	AC24	○
○ ○	AC24	○
○ ○	AC0	○
○ ○	AC0	○
○ ○	427	○ ○
○ ○	24V1	○ ○
○ ○	24V1	○ ○
○ ○	24V1	○ ○
○ ○	24V1	○ ○
○ ○	24V1	○ ○
○ ○	24V1	○ ○
○ ○	24V2	○ ○
○ ○	24V2	○ ○
○ ○	24V2	○ ○
○ ○	24V3	○ ○
○ ○	24V3	○ ○
○ ○	24V3	○ ○
○ ○	24G	○ ○
○ ○	24G	○ ○
○ ○	24G	○ ○
○ ○	24G	○ ○
○ ○	24G	○ ○
○ ○	24G	○ ○
○ ○	24G	○ ○
○ ○	24G	○ ○
○ ○	24G	○ ○
○ ○	24G	○ ○

TITLE: TB2 LAYOUT



DESIGNER	CONTROL	MACHINE	PAGE	VER
2014/02/14	MITSUBISHI		0071	A

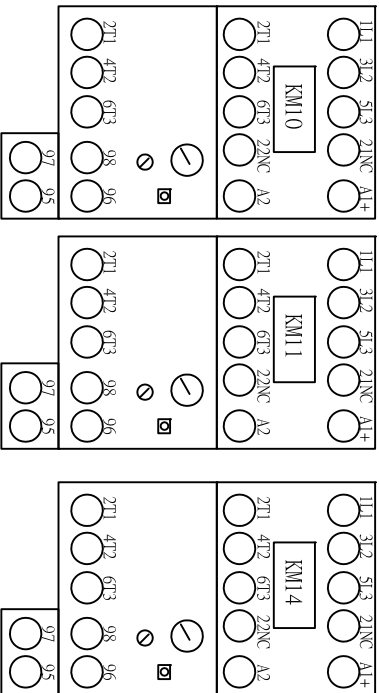
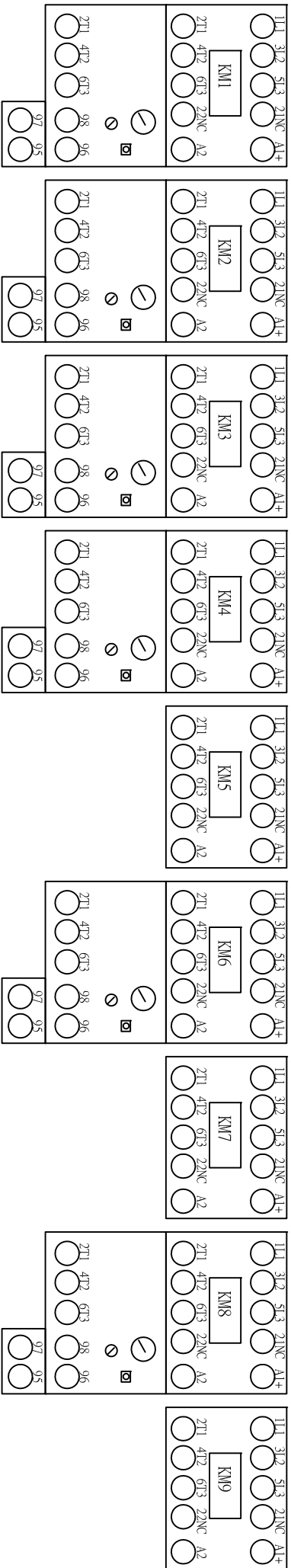

- KM1 = COOLANT A MOTOR CONTROL
- KM2 = COOLANT B MOTOR CONTROL
- KM3 = OIL COOLANT MOTOR CONTROL
- KM4 = CHIP CW MOTOR CONTROL
- KM5 = CHIP CCW MOTOR CONTROL
- KM6 = MAGAZINE CW MOTOR CONTROL
- KM7 = MAGAZINE CCW MOTOR CONTROL
- KM8 = ARM CW MOTOR CONTROL
- KM9 = ARM CCW MOTOR CONTROL
- KM10 = CTS SUCK MOTOR CONTROL <OPTION>
- KM11 = CTS TANK MOTOR CONTROL <OPTION>
- KM14 = CHAIN MOTOR CONTROL <OPTION>

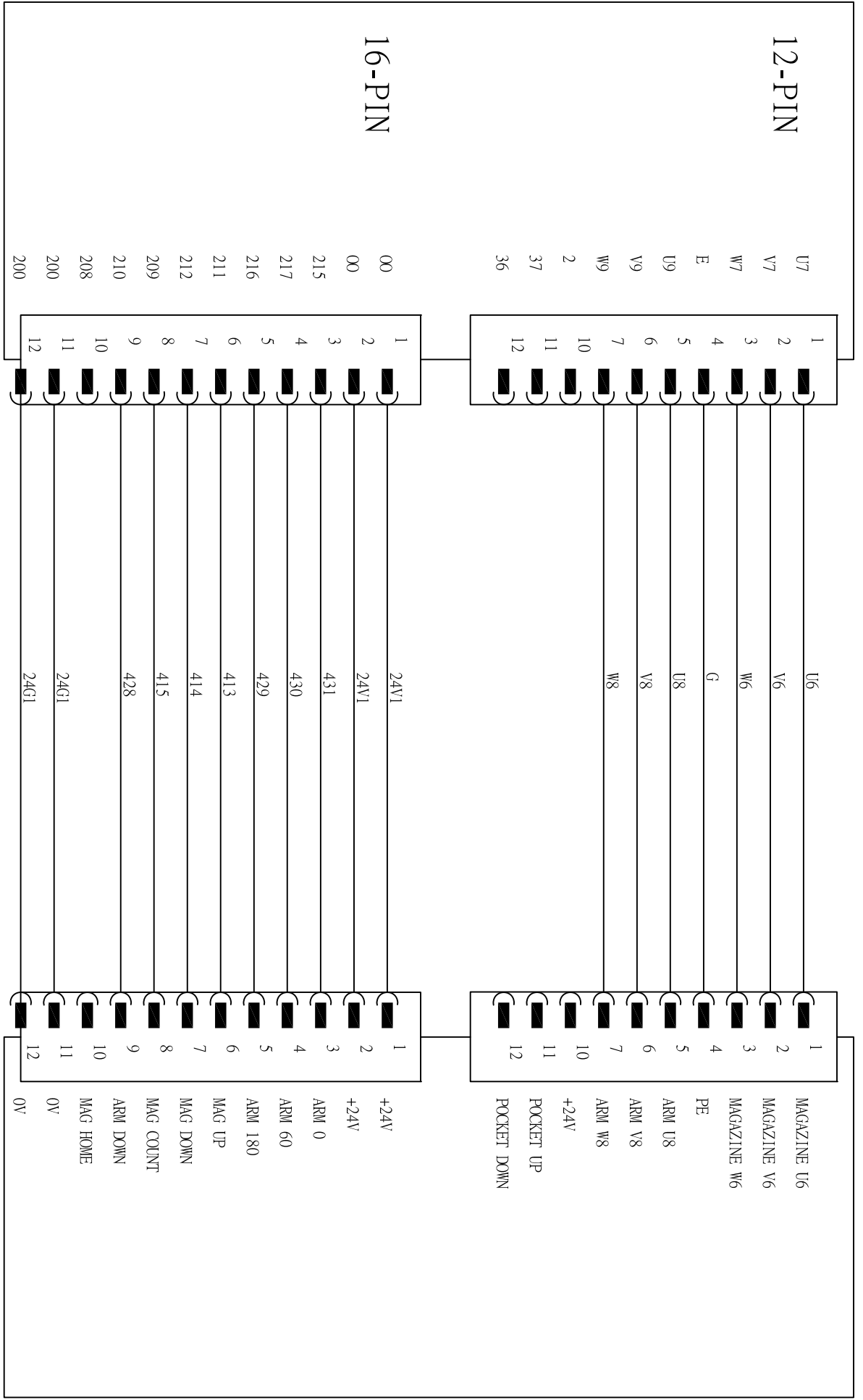

ARM TYPE
UNIT BOX

ELECTRICAL
CABINET

TITLE: ARM TYPE UNIT LAYOUT



DESIGNER	CONTROL	MACHINE	PAGE	VER
2014/02/14	MITSUBISHI		0073	A

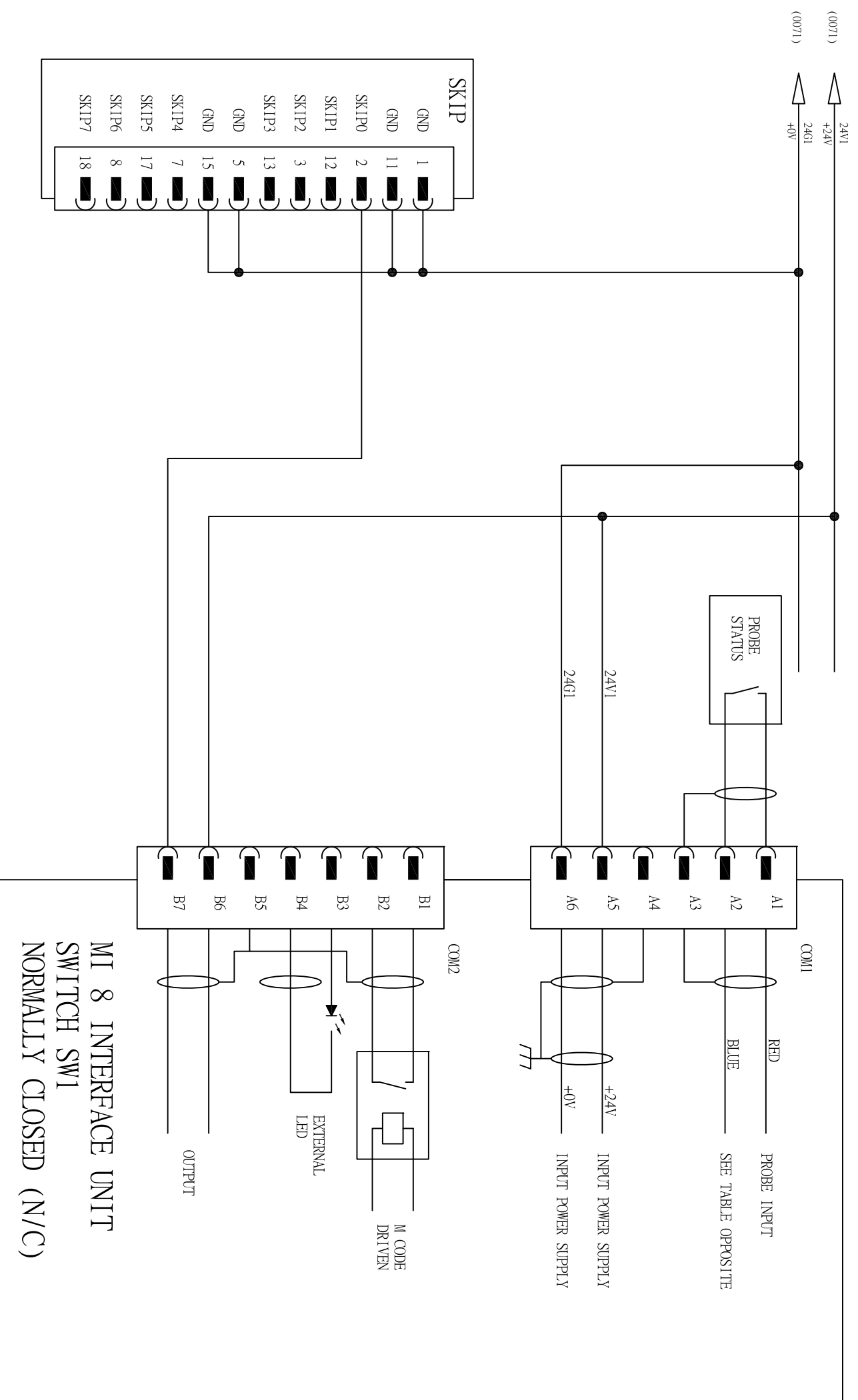

MI 8 INTERFACE UNIT
 SWITCH SW1
 NORMALLY CLOSED (N/C)

DESIGNER	CONTROL	MACHINE	PAGE	VER
2014/02/14	MITSUBISHI		0074	A

1 2 3 4 5 6 7 8 9

NO	CODE	TYPE	USED	MARK
01	POWER SUPPLY	MDS-D-CV-185		
02	SPINDLE DRIVE	MDS-D-SP-200/MDS-D-SPJ3-110		
03	X/Y/Z DRIVE	MDS-D-SVJ3-20/35NA		
04	Multi-hybrid DRIVE	MDS-DM-SPV3F-16018		
05	CONTROL UNIT	FCA70P-4AVU		
06	OPERATION PANEL	FCU7-KB026/KB048		
07	BASE I/O UNIT	FCU7-DX711		
08	REMOTE I/O	FCUA-DX111		
09	L100	D-AL-18.5K		
10	QF1	4710803220	FAZ-3-C20-20A	
11	QF2	4710800106	FAZNS 1P6A	
12	QF3	4710800106	FAZNS 1P6A	
13	QF4	4710800104	FAZNS 1P4A	
14	QF5	4710800104	FAZNS 1P4A	
15	QF6	4710800206	FAZNS 2P6A	
16	QF100	4801211350/4801211375	BW50 EAG3P050/BW100 EAG3P075	
17				
18	PCB1	4710431032	LDW RLY32	
19	PCB2	4710501502	JB01PDSB50M-2	
20	K1	4710021424	MY-2NJ DC24V	
21	K2	4710021424	MY-2NJ DC24V	
22	K3	4710021424	MY-2NJ DC24V	
23	K100	4710210505/4710210805	CN-50-H5/CN-80-H5	
24				
25				

DESIGNER	CONTROL	MACHINE	PAGE	VER
	2014/02/14		1000	A
LEADERWAY				
TITLE: COLTROLLER SYSTEM PART LIST				

1 2 3 4 5 6 7 8 9

NO	CODE	TYPE	USED	MARK
26	KM1	4710201901	DILM901D1	
27	KM2	4710201901	DILM901D1	
28	KM3	4710201901	DILM901D1	
29	KM4	4710201901	DILM901D1	
30	KM5	4710201901	DILM901D1	
31	KM6	4710201901	DILM901D1	
32	KM7	4710201901	DILM901D1	
33	KM8	4710201901	DILM901D1	
34	KM9	4710201901	DILM901D1	
35	KM10	4710201901	DILM901D1	
36	KM11	4710201901	DILM901D1	
37				
38	F1	4710001240	ZB12-4	
39	F2	4710001240	ZB12-4	
40	F3	4710001260	ZB12-6	
41	F4	4710001216	ZB12-1.6	
42	F6	4710001216	ZB12-1.6	
43	F8	4710001240	ZB12-4	
44	F10	4710001240	ZB12-4	
45	F11	4710001260	ZB12-6	
46	TR2	4710101001	1KVA	
47	SWP1	4710315024	S150-24V(6.5A)	
48	SWP2	4710315024	S150-24V(6.5A)	
49				
50				

DESIGNER		CONTROL	MACHINE	PAGE	VER
2014/02/14		mitsubishi		1001	A
LEADERWAY					
TITLE: COLTROLLER SYSTEM PART LIST					

M CODE LIST

B: BASIC
O: OPTION

CODE	FUNCTION	CLASS
M00	PROGRAM STOP	B
M01	OPTIONAL STOP TEMPORARILY	B
M02	PROGRAM END	B
M03	SPINDLE CLOCKWISE	B
M04	SPINDLE NCOUNTERCLOCKWISE	B
M05	SPINDLE STOP	B
M06	AUTOMATIC TOOL EXCHANGE	B
M07	C.T.S COOLANT ON	O
M08	COOLANT ON	B
M09	COOLANT OFF(CANCEL M07,M08,M10,M38 COMMANDMENTS)	B
M10	COOLANT B ON	O
M11		
M12		
M13	SPINDLE CLOCKWISE AND COOLANT ON	B
M14	SPINDLE COUNTERCLOCKWISE AND COOLANT ON	B
M15		
M16		
M17		
M18		
M19	SPINDLE ORIENTATION	B
M20		
M21	MAG RIGHT	O

VER	PAGE	MACHINE	CONTROL	DESIGNER
A	1002		MITSUBISHI	
LEADERWAY				
TITLE: M CODE LIST				
2014/02/14				

1 2 3 4 5 6 7 8 9

M CODE LIST

B: BASIC
O: OPTION

CODE	FUNCTION	CLASS
M22	MAG LEFT	O
M23	POCKET UP	B
M24	POCKET DOWN	B
M25	SPINDLE TOOL CLAMP	B
M26	SPINDLE TOOL UNCLAMP	B
M27		
M28		
M29		
M30	PROGRAM END AND ICON SKIP TO BEGINNING	B
M31		
M32		
M33		
M34		
M35		
M36		
M37		
M38	DEEP THROUGH TAPPING AND COOLANT ON	O
M39		
M40	4TH AXIS CLAMPPING	O
M41	4TH AXIS RELEASE	O
M42		
M43		

VER	PAGE	MACHINE	DESIGNER	2014/02/14
A	1003		MITSUBISHI	
LEADERWAY				
TITLE: M CODE LIST				

1 2 3 4 5 6 7 8 9

M CODE LIST

B: BASIC
O: OPTION

CODE	FUNCTION	CLASS
M44		
M45	COIL TYPE CHIP CONVEYOR CLOCKWISE ON	B
M46	COIL TYPE CHIP CONVEYOR CLOCKWISE OFF	B
M47	SPINDLE MACHINING AIR BLOW ON	B
M48	SPINDLE MACHINING AIR BLOW OFF	B
M49		
M50		
M51		
M52	ACTUAL STOP CHECKING EFFECTIVE	B
M53	ACTUAL STOP CHECKING CANCEL	B
M54		
M55		
M56	ATLM AIR ON	O
M57	ATLM AIR OFF	O
M58		
M59		
M60		
M61	MIRROR IMAGE X AXIS CANCEL	B
M62	MIRROR IMAGE Y AXIS CANCEL	B
M63		
M64	MIRROR IMAGE 4TH AXIS CANCEL	B
M65	MAG DOOR OPEN	O

VER	A
PAGE	1004
MACHINE	
CONTROL	MITSUBISHI
DESIGNER	2014/02/14
LEADERWAY	
TITLE: M CODE LIST	

1 2 3 4 5 6 7 8 9

M CODE LIST

B: BASIC
O: OPTION

CODE	FUNCTION	CLASS
M66	MAG DOOR CLOSE	0
M67		
M68		
M69		
M70		
M71	MIRROR IMAGE X AXIS WORK ON	B
M72	MIRROR IMAGE Y AXIS WORK ON	B
M73		
M74	MIRROR IMAGE 4TH AXIS WORK ON	B
M75		
M76		
M77		
M78		
M79		
M80		
M81	M81 : ON M82 : OFF	0
M82	M82 : ON M81 : OFF	0
M83	M83 : ON M84 : OFF	0
M84	M84 : ON M83 : OFF	0
M85	M85 : ON M86 : OFF	0
M86	M86 : ON M85 : OFF	0
M87	M87 : ON M88 : OFF	0

9
8
7
6
5
4
3
2
1

M CODE LIST

B: BASIC
O: OPTION

CODE	FUNCTION	CLASS
M88	M88 : ON M87 : OFF	0
M89		
M90		
M91		
M92		
M93		
M94		
M95	WORKPIECE COUNT NUMBER	B
M96		
M97		
M98		
M99		

DESIGNER	CONTROL	MACHINE	PAGE	VER
	MITSUBISHI		1006	A
2014/02/14				
LEADERWAY				
TITLE: M CODE LIST				

1 2 3 4 5 6 7 8 9

ALARM LIST

CODE	DESCRIPTION
F0	(F0)DOOR INTERLOCK
F1	(F1)SPINDLE RESISTOR TEMP
F2	(F2)ARM POSITON ERROR
F3	(F3)Z-AXIS NOT HOME
F4	(F4)X AXIS RESISTOR TEMP
F5	(F5)Y AXIS RESISTOR TEMP
F6	(F6)Z AXIS RESISTOR TEMP
F7	(F7)4 TH RESISTOR TEMP
F8	(F8)TOOL NO. < 1
F9	(F9)CLAMP ERROR
F10	(F10)SPINDLE ALARM
F11	(F11)LUBE OIL HI/LO ALARM
F12	(F12)AIR PRESSURE ALARM
F13	(F13)BATTERY ALARM
F14	(F14)MAGAZINE NOT ORIENT
F15	(F15)4TH CLAMP
F16	(F16)SPINDLE NOT TOOL
F17	(F17)SPINDLE STOP CUTTING
F18	(F18)PROGRAM RESTART ON
F19	(F19)LUBE PRESSURE ALARM
F20	(F20)SERVICE MODE ON
F21	(F21)TOOL SERCH ERROR

ALARM LIST

CODE	DESCRIPTION
F22	(F22)GEAR LIMIT FAULT
F23	(F23)OIL COOLER OVERLOAD
F24	(F24)BALANCE PRESSURE LOW
F25	(F25)COOLANT B OVERLOAD
F26	(F26)TOOL NO. DUBP.
F27	(F27)COOLANT MOTOR OVLD
F28	(F28)OIL COOLER ALARM
F29	(F29)ARM MOTOR OVERLOAD
F30	(F30)MAG. MOTOR OVERLOAD
F31	(F31)CHIP MOTOR OVERLOAD
F32	(F32)HYDRAULIC MOTOR OVLD
F33	(F33)5TH CLAMP
F34	(F34)FILTER A COLG
F35	(F35)GEAR PUMP MOTOR OVLD
F36	(F36)FILTER B COLG
F37	(F37)HI/LO SPEED ERROR
F38	(F38)4TH NOT HOME
F39	(F39)COOLANT B HI
F40	(F40) 3AXIS NEED HOME
F41	(F41) COOLANT LEVEL LOW
F42	(F42) TANK MOTOR OVERLOAD
F43	(F43) CTS MOTOR OVERLOAD

VER	A
PAGE	1008
MACHINE	
CONTROL	MITSUBISHI DESIGNER 2014/02/14
LEADERWAY	
TITLE: ALARM LIST	

1 2 3 4 5 6 7 8 9

ALARM LIST

CODE	DESCRIPTION
F44	(F44) CTS PRESSURE LOW
F45	(F45) CTS FILTER ALARM
F46	(F46) NO CTS SELECT
F47	(F47) SPZNDLE DISABLE DNOW
F48	(F48) PUMP A MOTOR ALARM
F49	(F49) COOLANT HIGH
F50	(F50) COOLANT LOW
F51	(F51) COOLANT HIGH
F52	(F52) TOOL UNCLAMP STATUS NOT START
F53	(F53) UNCLAMP ERROR
F54	(F54) SP SENSOR ERROR
F55	(F55) UNCLAMP/CLAMP SENSOR ERROR
F56	(F56) UP/DOWN SENSOR ERROR
F57	(F57) ARM SENSOR1 ERROR
F58	(F58) ARM SENSOR2 ERROR
F59	(F59) ARM SENSOR3 ERROR
F60	(F60) ARM SENSOR4 ERROR
F61	(F61) SP MOTOR ALARM
F62	(F62) X AXIS OT ALARM
F63	(F63) Y AXIS OT ALARM
F64	(F64) Z AXIS OT ALARM
F65	(F65) TOOL TOUCH ATLM

9
8
7
6
5
4
3
2
1

1 2 3 4 5 6 7 8 9

ALARM LIST

CODE	DESCRIPTION
F66	(F66) OVER TOOL MEASUREMENT
F67	(F67) TOOL CHANGE NOT ALREADY
F68	(F68) CHAIN MOTOR OVERLOAD
F69	(F69) MAG DOOR SENSOR ALARM
F70	(F70) MAG DOOR OPEN
F71	(F71))Y AXIS GO IN THE ATC AREA

DESIGNER	CONTROL	MACHINE	PAGE	VER
			1009	A

LEADERWAY

MITSUBISHI (NEW PANEL)

No.	Position	I/O Point	Use	T.Pos	Cable No.
1	DIL-A1		0V		0V
2	DIL-B1		+24V3		+24V3
3	DIL-A2		0V		0V
4	DIL-B2		+24V3		+24V3
5	DIL-A3		COM-0V		0V
6	DIL-B3		COM-0V		0V
7	DIL-A4	×	×		
8	DIL-B4	×	×		
9	DIL-A5	X1F	4 TH UNCLAMP	PCB4-16	416
10	DIL-B5	XF	LUBE LOW LEVEL ALARM	PCB4-08	408
11	DIL-A6	X1E	4 TH CLAMP	PCB4-17	417
12	DIL-B6	XE	TOOL UNCLAMP LS.	PCB4-06	406
13	DIL-A7	X1D	AIR ALARM	PCB4-07	407
14	DIL-B7	XD	TOOL CLAMP LS.(have tool)	PCB4-05	405
15	DIL-A8	X1C	MANUAL TOOL UNCLAMP PB.	PCB4-25	425
16	DIL-B8	XC	CHIP MOTOR OVERLOAD	PCB4-24	424
17	DIL-A9	X1B	*DEC 4	PCB4-32	432
18	DIL-B9	XB	LUBE PRESSURE LOW ALARM	PCB4-18	418
19	DIL-A10	X1A	*DEC Z	PCB4-12	412
20	DIL-B10	XA	TOOL CLAMP LS.(no have tool) OPTION	PCB4-19	419
21	DIL-A11	X19	*DEC Y	PCB4-11	411
22	DIL-B11	X9	DOOR INTERLOCK	PCB4-20	420
23	DIL-A12	X18	*DEC X	PCB4-10	410
24	DIL-B12	X8	COOLANT HIGH	PCB4-26	426
25	DIL-A13	X17	EMG	PCB4-27	427
26	DIL-B13	X7	ARM SENSOR 4	PCB4-28	428
27	DIL-A14	X16	ARM SENSOR 3	PCB4-29	429
28	DIL-B14	X6	POCKET UP(MAG LEFT)<DOOR CLOSE>	PCB4-13	413
29	DIL-A15	X15	ARM SENSOR 2	PCB4-30	430
30	DIL-B15	X5	POCKET DOWN(MAG RIGHT)<DOOR OPEN>	PCB4-14	414
31	DIL-A16	X14	ARM SENSOR 1	PCB4-31	431
32	DIL-B16	X4	COOLANT B MOTOR OVERLOAD	PCB4-23	423
33	DIL-A17	X13	MAG. MOTOR OVERLOAD	PCB4-36	436
34	DIL-B17	X3	MAG. COUNTER	PCB4-15	415
35	DIL-A18	X12	COOLANT LEVEL LOW	PCB4-09	409
36	DIL-B18	X2	MAG. ORIENTATION REFERENCE	PCB4-33	433
37	DIL-A19	X11	ARM MOTOR OVERLOAD	PCB4-34	434
38	DIL-B19	X1	OIL COOLER ALARM	PCB4-35	435
39	DIL-A20	X10	COOLANT MOTOR OVERLOAD	PCB4-22	422
40	DIL-B20	X0	OIL COOLER MOTOR OVERLOAD	PCB4-21	421

MITSUBISHI (NEW PANEL)

No.	Position	I/O Point	Use	T.Pos	Cable No.
41	DIR-A1		0V		0V
42	DIR-B1		+24V3		+24V3
43	DIR-A2		0V		0V
44	DIR-B2		+24V3		+24V3
45	DIR-A3		COM-0V		0V
46	DIR-B3		COM-0V		0V
47	DIR-A4	×	×		
48	DIR-B4	×	×		
49	DIR-A5	X3F	PROGRAM COOLANT SW		
50	DIR-B5	X2F	POSITION A	PCB4-01	401
51	DIR-A6	X3E			1001
52	DIR-B6	X2E	POSITION F	PCB4-02	402
53	DIR-A7	X3D			1002
54	DIR-B7	X2D	POSITION B	PCB4-03	403
55	DIR-A8	X3C			
56	DIR-B8	X2C	POSITION E	PCB4-04	404
57	DIR-A9	X3B	PROGRAM COOLANT PB		452
58	DIR-B9	X2B	Y AXIS TOOL CHANGE POINT		437
59	DIR-A10	X3A			453
60	DIR-B10	X2A	X AXIS TEMPERATURE MAX	PCB4-38	438
61	DIR-A11	X39	ATLM ALARM		454
62	DIR-B11	X29	Y AXIS TEMPERATURE MAX	PCB4-39	439
63	DIR-A12	X38	MANUAL MAG CW		455
64	DIR-B12	X28	Z AXIS TEMPERATURE MAX	PCB4-40	440
65	DIR-A13	X37	MANUAL MAG CCW		456
66	DIR-B13	X27	SP AXIS TEMPERATURE MAX	PCB4-41	441
67	DIR-A14	X36	FOOT SWITCH		457
68	DIR-B14	X26	4 AXIS TEMPERATURE MAX	PCB4-42	442
69	DIR-A15	X35	CHAIN MOTOR OVERLOAD		458
70	DIR-B15	X25	CTS PRESSURE LOW	PCB4-43	443
71	DIR-A16	X34			459
72	DIR-B16	X24	CTS FILTER ALARM	PCB4-44	444
73	DIR-A17	X33			460
74	DIR-B17	X23	TANK OVERLOAD	PCB4-45	445
75	DIR-A18	X32			461
76	DIR-B18	X22	SUCK OVERLOAD	PCB4-46	446
77	DIR-A19	X31	IPM SP OVERTEMPERATURE		462
78	DIR-B19	X21	CTS COOLANT LOW		447
79	DIR-A20	X30			463
80	DIR-B20	X20	CTS COOLANT HIGH		448

MITSUBISHI (NEW PANEL)

No.	Position	I/O Point	Use	Relay No.	Cable No.
1	DOL-A1		0V		0V
2	DOL-B1		24V3		24V3
3	DOL-A2		0V		0V
4	DOL-B2		24V3		24V3
5	DOL-A3				
6	DOL-B3				
7	DOL-A4				
8	DOL-B4				
9	DOL-A5	Y1F	M30 POWER OFF RELAY	R6	506
10	DOL-B5	YF	M81/M82 RELAY	R29	529
11	DOL-A6	Y1E	DOOR INTERLOCK RELAY	R31	531
12	DOL-B6	YE	M83/M84 RELAY	R32	532
13	DOL-A7	Y1D	ARM CW RELAY	R17	517
14	DOL-B7	YD	Z-BREAK RELAY	R19	519
15	DOL-A8	Y1C	ARM CCW RELAY	R18	518
16	DOL-B8	YC	COOLANT MOTOR RELAY	R22	522
17	DOL-A9	Y1B	TANK RELAL	R21	521
18	DOL-B9	YB	HIGH GEAR RELAY	R27	527
19	DOL-A10	Y1A	M41 4 TH UNCLAMP	R26	526
20	DOL-B10	YA	LOW GEAR RELAY	R28	528
21	DOL-A11	Y19	SPINDLE ROTATE BLOW RELAY	R30	530
22	DOL-B11	Y9	COOLANT A SOL. RELAY	R9	509
23	DOL-A12	Y18	M40 4 TH CLAMP	R25	525
24	DOL-B12	Y8	AUTO LUBE RELAY	R5	505
25	DOL-A13	Y17	CTS RELAY	R23	523
26	DOL-B13	Y7	CHIP CW RELAY	R15	515
27	DOL-A14	Y16	CHIP CCW RELAY	R16	516
28	DOL-B14	Y6	ALARM LAMP (GREEN)	R3	503
29	DOL-A15	Y15	WORK LAMP RELAY	R4	504
30	DOL-B15	Y5	MAG. CW RELAY	R7	507
31	DOL-A16	Y14	AIR BLOW RELAY	R12	512
32	DOL-B16	Y4	MAG. CCW RELAY	R8	508
33	DOL-A17	Y13	ALARM LAMP (RED)	R1	501
34	DOL-B17	Y3	POCKET DOWN SOL. RELAY	R14	514
35	DOL-A18	Y12	ALARM LAMP (YELLOW)	R2	502
36	DOL-B18	Y2	POCKET UP SOL. RELAY	R13	513
37	DOL-A19	Y11	ATC AIR BLAST RELAY	R11	511
38	DOL-B19	Y1	COOLANT B SOL. RELAY	R10	510
39	DOL-A20	Y10	ATC TOOL UNCLAMP RELAY	R20	520
40	DOL-B20	Y0	O.T RELEASE RELAY	R24	524

PS: FOR LX SERISE Y3 MAG DOOR OPEN RELAY
 Y2 MAG DOOR CLOSE RELAY

MITSUBISHI (NEW PANEL)

No.	Position	I/O Point	Use	Relay No.	Cable No.
1	DOR-A1		0V		0V
2	DOR-B1		24V3		24V3
3	DOR-A2		0V		0V
4	DOR-B2		24V3		24V3
5	DOR-A3				
6	DOR-B3				
7	DOR-A4				
8	DOR-B4				
9	DOR-A5	Y3F			
10	DOR-B5	Y2F	SPINDLE FAN RELAY	R33	533
11	DOR-A6	Y3E			
12	DOR-B6	Y2E	ATLM AIR BLOW RELAY	R34	534
13	DOR-A7	Y3D			
14	DOR-B7	Y2D		R35	535
15	DOR-A8	Y3C			
16	DOR-B8	Y2C		R36	536
17	DOR-A9	Y3B			
18	DOR-B9	Y2B	POSITION A(bit1)	R37	R37
19	DOR-A10	Y3A			
20	DOR-B10	Y2A	POSITION B(bit2)	R38	R38
21	DOR-A11	Y39			
22	DOR-B11	Y29	POSITION E(bit3)	R39	R39
23	DOR-A12	Y38			
24	DOR-B12	Y28	POSITION F(bit4)	R40	R40
25	DOR-A13	Y37			
26	DOR-B13	Y27		R41	R41
27	DOR-A14	Y36			
28	DOR-B14	Y26		R42	R42
29	DOR-A15	Y35			
30	DOR-B15	Y25	PROGRAM COOLANT LED	R43	R43
31	DOR-A16	Y34			
32	DOR-B16	Y24	SPARE	R44	R44
33	DOR-A17	Y33			
34	DOR-B17	Y23	SPARE	R45	R45
35	DOR-A18	Y32			
36	DOR-B18	Y22	SPARE	R46	R46
37	DOR-A19	Y31			
38	DOR-B19	Y21	SPARE	R47	R47
39	DOR-A20	Y30			
40	DOR-B20	Y20	SPARE	R48	R48

MITSUBISHI (NEW PANEL)

No.	Position	I/O Point	Use	No.	PIN-No.
1	CG31-A1	×	0V		CN1-61
2	CG31-B1	×	24V3		CN1-1
3	CG31-A2	×	0V		CN1-61
4	CG31-B2	×	24V3		CN1-1
5	CG31-A3	×	COM	0V	
6	CG31-B3	×	COM	0V	
7	CG31-A4	×	×	×	
8	CG31-B4	×	×	×	
9	CG31-A5	X21F	AUTO MODE PB		CN1-3
10	CG31-B5	X20F	MDI MODE PB		CN1-4
11	CG31-A6	X21E	EDIT MODE PB		CN1-5
12	CG31-B6	X20E	DNC MODE PB		CN1-6
13	CG31-A7	X21D	SINGLE BLOCK PB		CN1-7
14	CG31-B7	X20D	DRY RUN PB		CN1-8
15	CG31-A8	X21C	BLOCK DELETE PB		CN1-9
16	CG31-B8	X20C	OPTION STOP PB		CN1-10
17	CG31-A9	X21B	PROG. RESTART PB		CN1-11
18	CG31-B9	X20B	MPG MODE PB		CN1-12
19	CG31-A10	X21A	JOG MODE PB		CN1-13
20	CG31-B10	X20A	HOME MODE PB		CN1-14
21	CG31-A11	X219	+5 PB		CN1-15
22	CG31-B11	X209	+4 PB		CN1-16
23	CG31-A12	X218	-Y PB		CN1-17
24	CG31-B12	X208	+Z PB		CN1-18
25	CG31-A13	X217	O.T RELEASE PB		CN1-19
26	CG31-B13	X207	+X PB		CN1-20
27	CG31-A14	X216	RAPID PB		CN1-21
28	CG31-B14	X206	-X PB		CN1-22
29	CG31-A15	X215	-5 PB		CN1-23
30	CG31-B15	X205	-Z PB		CN1-24
31	CG31-A16	X214	+Y PB		CN1-25
32	CG31-B16	X204	-4 PB		CN1-26
33	CG31-A17	X213	SPINDLE OVERRIDE – PB		CN1-27
34	CG31-B17	X203	SPINDLE OVERRIDE 100% PB		CN1-28
35	CG31-A18	X212	SPINDLE OVERRIDE + PB		CN1-29
36	CG31-B18	X202	SPINDLE CW PB		CN1-30
37	CG31-A19	X211	SPINDLE STOP PB		CN1-31
38	CG31-B19	X201	SPINDLE CCW PB		CN1-32
39	CG31-A20	X210	CYCLE START PB		CN1-33
40	CG31-B20	X200	FEED HOLD PB		CN1-34

MITSUBISHI (NEW PANEL)

No.	Position	I/O Point	Use	No.	PIN- No
1	CG33-A1	×	0V		CN1-61,62
2	CG33-B1	×	24V3		CN1-1,2
3	CG33-A2	×	0V		CN1-61,62
4	CG33-B2	×	24V3		CN1-1,2
5	CG33-A3	×	COM	0V	
6	CG33-B3	×	COM	0V	
7	CG33-A4	×	×	×	
8	CG33-B4	×	×	×	
9	CG33-A5	X23F	WORK LIGHT PB		CN1-35
10	CG33-B5	X22F	SPINDLE AIR BLOW PB		CN1-36
11	CG33-A6	X23E	DOOR RELEASE PB		CN1-37
12	CG33-B6	X22E	ATC CW PB		CN1-38
13	CG33-A7	X23D	CHIP CW PB		CN1-39
14	CG33-B7	X22D	COOLANT A PB		CN1-40
15	CG33-A8	X23C	F1 PB		CN1-41
16	CG33-B8	X22C	F2 PB		CN1-42
17	CG33-A9	X23B	F3 PB		CN1-43
18	CG33-B9	X22B	ATC CCW PB		CN1-44
19	CG33-A10	X23A	CHIP CCW PB		CN1-45
20	CG33-B10	X22A	COOLANT B PB		CN1-46
21	CG33-A11	X239	PROGRAM PROTECT KEY		CN1-54
22	CG33-B11	X229	SKIP		CN1-55
23	CG33-A12	X238	ESKIP		CN1-56
24	CG33-B12	X228	FEEDRATE E		CN1-57
25	CG33-A13	X237	FEEDRATE B		CN1-58
26	CG33-B13	X227	FEEDRATE F		CN1-59
27	CG33-A14	X236	FEEDRATE A		CN1-60
28	CG33-B14	X226	HANDLE *1		CN2-54
29	CG33-A15	X235	HANDLE *10		CN2-55
30	CG33-B15	X225	HANDLE *100		CN2-56
31	CG33-A16	X234	HANDLE X		CN2-57
32	CG33-B16	X224	HANDLE Y		CN2-58
33	CG33-A17	X233	HANDLE Z		CN2-59
34	CG33-B17	X223	HANDLE 4		CN2-60
35	CG33-A18	X232	RAPID OVERRIDE F		CN4-14
36	CG33-B18	X222	RAPID OVERRIDE A		CN4-15
37	CG33-A19	X231			
38	CG33-B19	X221			
39	CG33-A20	X230			
40	CG33-B20	X220			

MITSUBISHI (NEW PANEL)

No.	Position	I/O Point	Use	No.	PIN- No.
1	CG32-A1	×	0V		CN2-62
2	CG32-B1	×	24V3		CN2-1,2
3	CG32-A2	×	0V		CN2-62
4	CG32-B2	×	24V3		CN2-1,2
5	CG32-A3	×	24V3		CN2-1,2
6	CG32-B3	×	24V3		CN2-1,2
7	CG32-A4	×	24V3		CN2-1,2
8	CG32-B4	×	24V3		CN2-1,2
9	CG32-A5	Y21F	AUTO MODE LED		CN2-3
10	CG32-B5	Y20F	MDI MODE LED		CN2-4
11	CG32-A6	Y21E	EDIT MODE LED		CN2-5
12	CG32-B6	Y20E	DNC MODE LED		CN2-6
13	CG32-A7	Y21D	SINGLE BLOCK LED		CN2-7
14	CG32-B7	Y20D	DRY RUN LED		CN2-8
15	CG32-A8	Y21C	BLOCK DELETE LED		CN2-9
16	CG32-B8	Y20C	OPTION STOP LED		CN2-10
17	CG32-A9	Y21B	PROG. RESTART LED		CN2-11
18	CG32-B9	Y20B	MPG MODE LED		CN2-12
19	CG32-A10	Y21A	JOG MODE LED		CN2-13
20	CG32-B10	Y20A	HOME MODE LED		CN2-14
21	CG32-A11	Y219	+5 LED		CN2-15
22	CG32-B11	Y209	+4 LED		CN2-16
23	CG32-A12	Y218	-Y LED		CN2-17
24	CG32-B12	Y208	+Z LED		CN2-18
25	CG32-A13	Y217	O.T RELEASE LED		CN2-19
26	CG32-B13	Y207	+X LED		CN2-20
27	CG32-A14	Y216	RAPID LED		CN2-21
28	CG32-B14	Y206	-X LED		CN2-22
29	CG32-A15	Y215	-5 LED		CN2-23
30	CG32-B15	Y205	-Z LED		CN2-24
31	CG32-A16	Y214	+Y LED		CN2-25
32	CG32-B16	Y204	-4 LED		CN2-26
33	CG32-A17	Y213	SPINDLE OVERRIDE – LED		CN2-27
34	CG32-B17	Y203	SPINDLE OVERRIDE 100% LED		CN2-28
35	CG32-A18	Y212	SPINDLE OVERRIDE + LED		CN2-29
36	CG32-B18	Y202	SPINDLE CW LED		CN2-30
37	CG32-A19	Y211	SPINDLE STOP LED		CN2-31
38	CG32-B19	Y201	SPINDLE CCW LED		CN2-32
39	CG32-A20	Y210	CYCLE START LED		CN2-33
40	CG32-B20	Y200	FEED HOLD LED		CN2-34

MITSUBISHI (NEW PANEL)

No.	Position	I/O Point	Use	No.	PIN-No.
1	CG34-A1	×	0V		CN2-62
2	CG34-B1	×	24V3		CN2-1,2
3	CG34-A2	×	0V		CN2-62
4	CG34-B2	×	24V3		CN2-1,2
5	CG34-A3	×	24V3		CN2-1,2
6	CG34-B3	×	24V3		CN2-1,2
7	CG34-A4	×	24V3		CN2-1,2
8	CG34-B4	×	24V3		CN2-1,2
9	CG34-A5	Y23F	WORK LIGHT LED		CN2-35
10	CG34-B5	Y22F	SPINDLE AIR BLOW LED		CN2-36
11	CG34-A6	Y23E	DOOR RELEASE LED		CN2-37
12	CG34-B6	Y22E	ATC CW LED		CN2-38
13	CG34-A7	Y23D	CHIP CW LED		CN2-39
14	CG34-B7	Y22D	COOLANT A LED		CN2-40
15	CG34-A8	Y23C	F1 LED		CN2-41
16	CG34-B8	Y22C	F2 LED		CN2-42
17	CG34-A9	Y23B	F3 LED		CN2-43
18	CG34-B9	Y22B	ATC CCW LED		CN2-44
19	CG34-A10	Y23A	CHIP CCW LED		CN2-45
20	CG34-B10	Y22A	COOLANT B LED		CN2-46
21	CG34-A11	Y239	HANDLE LED		CN2-61
22	CG34-B11	Y229	COOLANT ALARM LED		CN4-1
23	CG34-A12	Y238	LUBE ALARM LED		CN4-2
24	CG34-B12	Y228	EMG. ALARM LED		CN4-3
25	CG34-A13	Y237	AIR ALARM LED		CN4-4
26	CG34-B13	Y227	HYD. ALARM LED		CN4-5
27	CG34-A14	Y236	DEC. X LED		CN4-6
28	CG34-B14	Y226	DEC. Y LED		CN4-7
29	CG34-A15	Y235	DEC. Z LED		CN4-8
30	CG34-B15	Y225	DEC. 4 LED		CN4-9
31	CG34-A16	Y234	DEC. 5 LED		CN4-10
32	CG34-B16	Y224	NC READY LED		CN4-11
33	CG34-A17	Y233			
34	CG34-B17	Y223			
35	CG34-A18	Y232			
36	CG34-B18	Y222			
37	CG34-A19	Y231			
38	CG34-B19	Y221			
39	CG34-A20	Y230			
40	CG34-B20	Y220			

M CODE LIST

M 碼	ENGLISH英文說明	CHINESE中文說明	B: BASIC O: OPTION
M00	Program stop	程式停止	B
M01	Program optional stop	程式選擇性停止	B
M02	Ent of program	程式結束	B
M03	Spindle CW	主軸正轉	B
M04	Spindle CCW	主軸反轉	B
M05	Spindle STOP	主軸停止	B
M06	AUTO TOOL CHANGE	刀具交換	B
M07	C.T.S. COOLANT ON	中心出水開啟	O
M08	COOLANT A ON	切削液開啟	B
M09	COOLANT OFF	切削液停止	B
M10	COOLANT B ON	環噴切削液開啟	O
M13	Spindle CW & COOLANT ON	主軸正轉&切削液開啟	B
M14	Spindle CCW COOLANT ON	主軸反轉&切削液開啟	B
M19	Spindle Orientation on	主軸定位	B
M23	MAGAZINE POCKET UP	刀庫-刀套水平	B
M24	MAGAZINE POCKET DOWN	刀庫-刀套垂直	B
M25	Spindle TOOL CLAMP	主軸夾刀	B
M26	Spindle TOOL UNCLAMP	主軸鬆刀	B
M30	M30 END Program rewind	M30程式結束	B
M38	COOLANT THROUGH TOOL ON	油路刀把啟動	O
M40	4 TH CLAMP	第四軸夾緊	O
M41	4 TH UNCLAMP	第四軸放鬆	O
M45	CHIP CW ON	捲削機正轉啟動	B
M46	CHIP CW OFF	捲削機正轉停止	B
M47	AIR BLOW ON	可程式吹氣啟動	B
M48	AIR BLOW OFF	可程式吹氣停止	B
M65	MAG DOOR OPEN	刀庫門開	O
M66	MAG DOOR CLOSE	刀庫門關	O
M81	M81:ON M82:OFF		O
M82	M82:ON M81:OFF		O
M83	M83:ON M84:OFF		O
M84	M84:ON M83:OFF		O
M85	M85:ON M86:OFF		O
M86	M86:ON M85:OFF		O
M87	M87:ON M88:OFF		O
M88	M88:ON M87:OFF		O
M95	WORKPIECE COUNT NUMBER	工件計數	B

中文 M70 ALARM LIST

CODE	DESCRIPTION	CHINESE中文說明	處理方式
F0	I000, (F0) DOOR INTERLOCK		
A1	I001, (F1) SPINDLE RESISTOR TEMP	(F1)主軸洩放電組過溫	請電洽機械原廠處理
F2	I002, (F2) ARM POSITION ERROR		
F3	I003, (F3) Z-AXIS NOT HOME NOT HOME		
F4	I004, (F4) X AXIS RESISTOR TEMP	(F4)X 軸洩放電組過溫	請電洽機械原廠處理
F5	I005, (F5) Y AXIS RESISTOR TEMP	(F5)Y 軸洩放電組過溫	請電洽機械原廠處理
F6	I006, (F6) Z AXIS RESISTOR TEMP	(F6)Z 軸洩放電組過溫	請電洽機械原廠處理
F7	I007, (F7) 4 THE RESISTOR TEMP		
F8	I008, (F8) TOOL NO. < 1		
F9	I009, (F9) CLAMP ERROR	(F9)夾刀SENSOR故障	請電洽機械原廠處理
F10	I010, (F10) SPINDLE ALARM	(F10)主軸 ALARM	請電洽機械原廠處理
F11	I011, (F11) LUNE OIL LOW ALARM	(F11)潤滑油機油量不足	加滿油
F12	I012, (F12) AIR PRESSURE ALARM(F12)	(F12)空氣壓力不足	壓力請調整到 6~8 Bar
F13	I013, (F13) BATTERY ALARM	(F13)電池電壓太低	請電洽機械原廠處理
F14	I014, (F14) MAGAZINE NOT ORIENT		
F15	I015, (F15) 4TH CLAMP		
F16	I016, (F16) SPINDLE NOT TOOL		
F17	I017, (F17) SPINDLE STOP CUTTING		
F18	I018, (F18) PROGRAM RESTART ON		
F19	I019, (F19) LUBE PRESSURE ALARM	(F19)潤滑油機壓力太低	請見後面操作說明
F20	I020, (F20) SERVICE MODE ON		
F21	I021, (F21) TOOL SEARCH ERROR		
F22	I022, (F22) GEAR LIMIT FAULT		
F23	I023, (F23) OIL COOLER OVERLOAD	(F23)主軸油冷機過載	請關機，然後按下 或壓彈數次 KM3 藍色鈕
F24	I024, (F24) BALANCE PRESSURE LOW		
F25	I025, (F25) COOLANT B OVERLOAD		
F26	I026, (F26) TOOL NO. DUBP.		
F27	I027, (F27) COOLANT MOTOR OVLD	(F27)切削液 A 馬達過載	請關機，然後按下 或壓彈數次 KM1 藍色鈕
F28	I028, (F28) OIL COOLER ALARM	(F28)主軸油冷機壓力低	壓力低，可能壓縮機故障或是沒冷卻油，請加油
F29	I029, (F29) ARM MOTOR OVERLOAD		
F30	I030, (F30) MAG. MOTOR OVERLOAD	(F30)刀盤馬達過載	請關機，然後按下 或壓彈數次 KM6 /KM7 藍色鈕
F31	I031, (F31) CHIP MOTOR OVERLOAD	(F31)排屑馬達過載	請關機，然後按下 或壓彈數次 KM4 /KM5 藍色鈕
F32	I032, (F32) HYDRAULIC MOTOR OVLD	(F32)油壓馬達過載	
F33	I033, (F33) 5TH CLAMP	(F33)第5軸夾住	
F34	I034, (F34) FILTER A COLG		
F35	I035, (F35) GEAR PUMP MOTOR OVLD	(F35)齒輪馬達過載	
F36	I036, (F36) FILTER B COLG		
F37	I037, (F37) HI/LO SPEED ERROR	(F37)齒輪高低速錯誤	
F38	I038, (F38) 4TH NOT HOME	(F38)第四軸沒回原點	
F39	I039, (F39) COOLANT B HI	(F39)水箱B太高	
F40	I040, (F40) 3 AXIS NEED HOME	(F40)三軸須要回HOME	
F41	I041, (F41) COOLANT LEVEL LOW		
F42	I042, (F42) TANK MOTOR OVERLOAD		
F43	I043, (F43) CTS MOTOR OVERLOAD		
F44	I044, (F44) CTS PRESSURE LOW		
F45	I045, (F45) CTS FILTER ALARM		
F46	I046, (F46) NO CTS SELECT		
F47	I047, (F47) SPINDLE DISABLE NOW	(F47) 主軸停止工作中	
F48	I048, (F48) PUMP A MOTOR ALARM		
F49	I049, (F49) COOLANT HIGH		
F50	I050, (F50) COOLANT LOW		
F51	I051, (F51) COOLANT HIGH		
F52	I052, (F52) TOOL UNCLAMP STATUS NOT		
F53	I053, (F53) UNCLAMP ERROR		
F54	I054, (F54) SP SENSOR ERROR		
F55	I055, (F55) UNCLAMP/CLAMP SENSOR ERROR		
F56	I056, (F56) UP/DOWN SENSOR ERROR		
F57	I057, (F57) ARM SENSOR1 ERROR		
F58	I058, (F58) ARM SENSOR2 ERROR		
F59	I059, (F59) ARM SENSOR3 ERROR		
F60	I060, (F60) ARM SENSOR4 ERROR		
F61	I061, (F61) SP MOTOR ALARM		
F62			
F63			
F64			

MITSUBISHI (NEW PANEL)

No.	Position	I/O Point	Use	T.Pos	Cable No.
1	DIL-A1		0V		0V
2	DIL-B1		+24V3		+24V3
3	DIL-A2		0V		0V
4	DIL-B2		+24V3		+24V3
5	DIL-A3		COM-0V		0V
6	DIL-B3		COM-0V		0V
7	DIL-A4	×	×		
8	DIL-B4	×	×		
9	DIL-A5	X1F	第四軸鬆 訊號點	PCB4-16	416
10	DIL-B5	XF	潤滑油位低訊號點	PCB4-08	408
11	DIL-A6	X1E	第四軸夾 訊號	PCB4-17	417
12	DIL-B6	XE	主軸鬆刀訊號	PCB4-06	406
13	DIL-A7	X1D	空壓不足訊號	PCB4-07	407
14	DIL-B7	XD	主軸夾刀訊號	PCB4-05	405
15	DIL-A8	X1C	鬆刀按鈕訊號	PCB4-25	425
16	DIL-B8	XC	排削機過載訊號	PCB4-24	424
17	DIL-A9	X1B		PCB4-32	432
18	DIL-B9	XB	潤滑油壓力不足訊號	PCB4-18	418
19	DIL-A10	X1A		PCB4-12	412
20	DIL-B10	XA	主軸夾刀(無刀)選配訊號	PCB4-19	419
21	DIL-A11	X19		PCB4-11	411
22	DIL-B11	X9	CE 門鎖訊號	PCB4-20	420
23	DIL-A12	X18		PCB4-10	410
24	DIL-B12	X8	水箱水位高訊號	PCB4-26	426
25	DIL-A13	X17	緊急停止訊號	PCB4-27	427
26	DIL-B13	X7	手臂刀信號 4	PCB4-28	428
27	DIL-A14	X16	手臂刀信號 3	PCB4-29	429
28	DIL-B14	X6	刀套上(刀庫左) 訊號<刀庫門關>	PCB4-13	413
29	DIL-A15	X15	手臂刀信號 2	PCB4-30	430
30	DIL-B15	X5	刀套下(刀庫右) 訊號<刀庫門開>	PCB4-14	414
31	DIL-A16	X14	手臂刀信號 1	PCB4-31	431
32	DIL-B16	X4	COOLANT B 馬達過載訊號	PCB4-23	423
33	DIL-A17	X13	刀庫馬達過載訊號	PCB4-36	436
34	DIL-B17	X3	刀庫數刀訊號	PCB4-15	415
35	DIL-A18	X12	水箱水位低訊號	PCB4-09	409
36	DIL-B18	X2	刀庫原點訊號	PCB4-33	433
37	DIL-A19	X11	手臂刀馬達過載訊號	PCB4-34	434
38	DIL-B19	X1	主軸油冷機錯誤訊號	PCB4-35	435
39	DIL-A20	X10	切削液馬達過載訊號	PCB4-22	422
40	DIL-B20	X0	主軸油冷機過載訊號	PCB4-21	421

MITSUBISHI (NEW PANEL)

No.	Position	I/O Point	Use	T.Pos	Cable No.
41	DIR-A1		0V		0V
42	DIR-B1		+24V3		+24V3
43	DIR-A2		0V		0V
44	DIR-B2		+24V3		+24V3
45	DIR-A3		COM-0V		0V
46	DIR-B3		COM-0V		0V
47	DIR-A4	×	×		
48	DIR-B4	×	×		
49	DIR-A5	X3F	可程式噴水自動/手動開關(選配) 訊號		
50	DIR-B5	X2F	可程式噴水旋鈕訊號 A (選配)	PCB4-01	401
51	DIR-A6	X3E			1001
52	DIR-B6	X2E	可程式噴水旋鈕訊號 F (選配)	PCB4-02	402
53	DIR-A7	X3D			1002
54	DIR-B7	X2D	可程式噴水旋鈕訊號 B (選配)	PCB4-03	403
55	DIR-A8	X3C			
56	DIR-B8	X2C	可程式噴水旋鈕訊號 E (選配)	PCB4-04	404
57	DIR-A9	X3B	可程式噴水設定按鈕(選配) 訊號		452
58	DIR-B9	X2B	Y 軸換刀點		437
59	DIR-A10	X3A			453
60	DIR-B10	X2A	X 軸洩放電組過溫度訊號	PCB4-38	438
61	DIR-A11	X39	刀具量測過行程訊號		454
62	DIR-B11	X29	Y 軸洩放電組過溫度訊號	PCB4-39	439
63	DIR-A12	X38	手動刀庫正轉訊號		455
64	DIR-B12	X28	Z 軸洩放電組過溫度訊號	PCB4-40	440
65	DIR-A13	X37	手動刀庫反轉訊號		456
66	DIR-B13	X27	主軸洩放電組過溫度訊號	PCB4-41	441
67	DIR-A14	X36	腳踏開關訊號		457
68	DIR-B14	X26	第四軸洩放電組過溫度訊號	PCB4-42	442
69	DIR-A15	X35	龍船排削馬達過載訊號		458
70	DIR-B15	X25	CTS 壓力低訊號	PCB4-43	443
71	DIR-A16	X34			459
72	DIR-B16	X24	CTS 濾網太髒訊號	PCB4-44	444
73	DIR-A17	X33			460
74	DIR-B17	X23	CTS 抽水馬達過載訊號	PCB4-45	445
75	DIR-A18	X32			461
76	DIR-B18	X22	CTS 噴水馬達過載訊號	PCB4-46	446
77	DIR-A19	X31	內藏式主軸過熱訊號		462
78	DIR-B19	X21	CTS 水箱水位低訊號		447
79	DIR-A20	X30			463
80	DIR-B20	X20	CTS 水箱水位高訊號		448

MITSUBISHI (NEW PANEL)

No.	Position	I/O Point	Use	Relay No.	Cable No.
1	DOL-A1		0V		0V
2	DOL-B1		24V3		24V3
3	DOL-A2		0V		0V
4	DOL-B2		24V3		24V3
5	DOL-A3				
6	DOL-B3				
7	DOL-A4				
8	DOL-B4				
9	DOL-A5	Y1F	M30 自動斷電繼電器	R6	506
10	DOL-B5	YF	M81/M82 輸出	R29	529
11	DOL-A6	Y1E	CE 門鎖繼電器	R31	531
12	DOL-B6	YE	M83/M84 輸出	R32	532
13	DOL-A7	Y1D	手臂刀正轉繼電器	R17	517
14	DOL-B7	YD		R19	519
15	DOL-A8	Y1C	手臂刀反轉繼電器	R18	518
16	DOL-B8	YC	切削液馬達繼電器	R22	522
17	DOL-A9	Y1B	CTS 抽水馬達繼電器	R21	521
18	DOL-B9	YB	齒輪高檔繼電器	R27	527
19	DOL-A10	Y1A	第四軸鬆繼電器	R26	526
20	DOL-B10	YA	齒輪低檔繼電器	R28	528
21	DOL-A11	Y19	主軸旋轉清潔吹氣繼電器	R30	530
22	DOL-B11	Y9	主軸切銷液繼電器	R9	509
23	DOL-A12	Y18	第四軸夾 繼電器	R25	525
24	DOL-B12	Y8	潤滑油繼電器繼電器	R5	505
25	DOL-A13	Y17	CTS 繼電器	R23	523
26	DOL-B13	Y7	排削機正轉繼電器	R15	515
27	DOL-A14	Y16	排削機反轉繼電器	R16	516
28	DOL-B14	Y6	三色燈綠色繼電器	R3	503
29	DOL-A15	Y15	工作燈繼電器	R4	504
30	DOL-B15	Y5	刀盤正轉繼電器	R7	507
31	DOL-A16	Y14	可程式 M47 吹氣繼電器	R12	512
32	DOL-B16	Y4	刀盤反轉繼電器	R8	508
33	DOL-A17	Y13	三色燈紅色繼電器	R1	501
34	DOL-B17	Y3	刀套下/刀庫右繼電器<刀庫門開>	R14	514
35	DOL-A18	Y12	三色燈黃色繼電器	R2	502
36	DOL-B18	Y2	刀套上/刀庫左繼電器<刀庫門關>	R13	513
37	DOL-A19	Y11	主軸換刀清潔吹氣繼電器	R11	511
38	DOL-B19	Y1	側沖切銷液繼電器	R10	510
39	DOL-A20	Y10	主軸鬆刀繼電器	R20	520
40	DOL-B20	Y0	極限解除繼電器	R24	524

MITSUBISHI (NEW PANEL)

No.	Position	I/O Point	Use	Relay No.	Cable No.
1	DOR-A1		0V		0V
2	DOR-B1		24V3		24V3
3	DOR-A2		0V		0V
4	DOR-B2		24V3		24V3
5	DOR-A3				
6	DOR-B3				
7	DOR-A4				
8	DOR-B4				
9	DOR-A5	Y3F			
10	DOR-B5	Y2F		R33	533
11	DOR-A6	Y3E			
12	DOR-B6	Y2E	量刀吹氣繼電器	R34	534
13	DOR-A7	Y3D			
14	DOR-B7	Y2D		R35	535
15	DOR-A8	Y3C			
16	DOR-B8	Y2C		R36	536
17	DOR-A9	Y3B			
18	DOR-B9	Y2B	可程式噴水 bit1(選配)	R37	R37
19	DOR-A10	Y3A			
20	DOR-B10	Y2A	可程式噴水 bit2(選配)	R38	R38
21	DOR-A11	Y39			
22	DOR-B11	Y29	可程式噴水 bit3(選配)	R39	R39
23	DOR-A12	Y38			
24	DOR-B12	Y28	可程式噴水 bit4(選配)	R40	R40
25	DOR-A13	Y37			
26	DOR-B13	Y27	SPARE	R41	R41
27	DOR-A14	Y36			
28	DOR-B14	Y26	SPARE	R42	R42
29	DOR-A15	Y35			
30	DOR-B15	Y25	可程式噴水按鈕燈	R43	R43
31	DOR-A16	Y34			
32	DOR-B16	Y24	SPARE	R44	R44
33	DOR-A17	Y33			
34	DOR-B17	Y23	SPARE	R45	R45
35	DOR-A18	Y32			
36	DOR-B18	Y22	SPARE	R46	R46
37	DOR-A19	Y31			
38	DOR-B19	Y21	SPARE	R47	R47
39	DOR-A20	Y30			
40	DOR-B20	Y20	SPARE	R48	R48

MITSUBISHI (NEW PANEL)

No.	Position	I/O Point	Use	No.	PIN-No.
1	CG31-A1	×	0V		CN1-61
2	CG31-B1	×	24V3		CN1-1
3	CG31-A2	×	0V		CN1-61
4	CG31-B2	×	24V3		CN1-1
5	CG31-A3	×	COM	0V	
6	CG31-B3	×	COM	0V	
7	CG31-A4	×	×	×	
8	CG31-B4	×	×	×	
9	CG31-A5	X21F	自動執行模式按鈕		CN1-3
10	CG31-B5	X20F	手動輸入模式按鈕		CN1-4
11	CG31-A6	X21E	程式編輯模式按鈕		CN1-5
12	CG31-B6	X20E	電腦傳輸模式按鈕		CN1-6
13	CG31-A7	X21D	單節執行按鈕		CN1-7
14	CG31-B7	X20D	程式預演按鈕		CN1-8
15	CG31-A8	X21C	單節跳躍按鈕		CN1-9
16	CG31-B8	X20C	選擇停止按鈕		CN1-10
17	CG31-A9	X21B	程式再啟動按鈕		CN1-11
18	CG31-B9	X20B	手輪進給模式按鈕		CN1-12
19	CG31-A10	X21A	手動進給模式按鈕		CN1-13
20	CG31-B10	X20A	原點復歸模式按鈕		CN1-14
21	CG31-A11	X219	+5 按鈕		CN1-15
22	CG31-B11	X209	+4 按鈕		CN1-16
23	CG31-A12	X218	-Y 按鈕		CN1-17
24	CG31-B12	X208	+Z 按鈕		CN1-18
25	CG31-A13	X217	越程釋放按鈕		CN1-19
26	CG31-B13	X207	+X 按鈕		CN1-20
27	CG31-A14	X216	快速進給按鈕		CN1-21
28	CG31-B14	X206	-X 按鈕		CN1-22
29	CG31-A15	X215	-5 按鈕		CN1-23
30	CG31-B15	X205	-Z 按鈕		CN1-24
31	CG31-A16	X214	+Y 按鈕		CN1-25
32	CG31-B16	X204	-4 按鈕		CN1-26
33	CG31-A17	X213	主軸減速按鈕		CN1-27
34	CG31-B17	X203	主軸 100% 按鈕		CN1-28
35	CG31-A18	X212	主軸加速按鈕		CN1-29
36	CG31-B18	X202	主軸正轉按鈕		CN1-30
37	CG31-A19	X211	主軸停止按鈕		CN1-31
38	CG31-B19	X201	主軸反轉按鈕		CN1-32
39	CG31-A20	X210	程式啟動按鈕		CN1-33
40	CG31-B20	X200	程式停止按鈕		CN1-34

MITSUBISHI (NEW PANEL)

No.	Position	I/O Point	Use	No.	PIN- No
1	CG33-A1	×	0V		CN1-61,62
2	CG33-B1	×	24V3		CN1-1,2
3	CG33-A2	×	0V		CN1-61,62
4	CG33-B2	×	24V3		CN1-1,2
5	CG33-A3	×	COM	0V	
6	CG33-B3	×	COM	0V	
7	CG33-A4	×	×	×	
8	CG33-B4	×	×	×	
9	CG33-A5	X23F	工作燈按鈕		CN1-35
10	CG33-B5	X22F	加工吹氣按鈕		CN1-36
11	CG33-A6	X23E	門鎖釋放按鈕		CN1-37
12	CG33-B6	X22E	刀盤正轉按鈕		CN1-38
13	CG33-A7	X23D	排屑正轉按鈕		CN1-39
14	CG33-B7	X22D	切銷液 A 按鈕		CN1-40
15	CG33-A8	X23C	F1 按鈕		CN1-41
16	CG33-B8	X22C	F2 按鈕		CN1-42
17	CG33-A9	X23B	F3 按鈕		CN1-43
18	CG33-B9	X22B	刀盤反轉按鈕		CN1-44
19	CG33-A10	X23A	排屑反轉按鈕		CN1-45
20	CG33-B10	X22A	切銷液 B 按鈕		CN1-46
21	CG33-A11	X239	程式保護鑰匙開關		CN1-54
22	CG33-B11	X229			CN1-55
23	CG33-A12	X238			CN1-56
24	CG33-B12	X228	切削進給率旋鈕訊號 E		CN1-57
25	CG33-A13	X237	切削進給率旋鈕訊號 B		CN1-58
26	CG33-B13	X227	切削進給率旋鈕訊號 F		CN1-59
27	CG33-A14	X236	切削進給率旋鈕訊號 A		CN1-60
28	CG33-B14	X226	手倫旋鈕 *1		CN2-54
29	CG33-A15	X235	手倫旋鈕*10		CN2-55
30	CG33-B15	X225	手倫旋鈕*100		CN2-56
31	CG33-A16	X234	手倫旋鈕 X		CN2-57
32	CG33-B16	X224	手倫旋鈕 Y		CN2-58
33	CG33-A17	X233	手倫旋鈕 Z		CN2-59
34	CG33-B17	X223	手倫旋鈕 4		CN2-60
35	CG33-A18	X232	快速進給率旋鈕訊號 F		CN4-14
36	CG33-B18	X222	快速進給率旋鈕訊號 A		CN4-15
37	CG33-A19	X231			
38	CG33-B19	X221			
39	CG33-A20	X230			
40	CG33-B20	X220			

MITSUBISHI (NEW PANEL)

No.	Position	I/O Point	Use	No.	PIN- No.
1	CG32-A1	×	0V		CN2-62
2	CG32-B1	×	24V3		CN2-1,2
3	CG32-A2	×	0V		CN2-62
4	CG32-B2	×	24V3		CN2-1,2
5	CG32-A3	×	24V3		CN2-1,2
6	CG32-B3	×	24V3		CN2-1,2
7	CG32-A4	×	24V3		CN2-1,2
8	CG32-B4	×	24V3		CN2-1,2
9	CG32-A5	Y21F	自動執行模式 LED		CN2-3
10	CG32-B5	Y20F	手動輸入模式 LED		CN2-4
11	CG32-A6	Y21E	程式編輯模式 LED		CN2-5
12	CG32-B6	Y20E	電腦傳輸模式 LED		CN2-6
13	CG32-A7	Y21D	單節執行 LED		CN2-7
14	CG32-B7	Y20D	程式預演 LED		CN2-8
15	CG32-A8	Y21C	單節跳躍 LED		CN2-9
16	CG32-B8	Y20C	選擇停止 LED		CN2-10
17	CG32-A9	Y21B	程式再啟動 LED		CN2-11
18	CG32-B9	Y20B	手輪進給模式 LED		CN2-12
19	CG32-A10	Y21A	手動進給模式 LED		CN2-13
20	CG32-B10	Y20A	原點復歸模式 LED		CN2-14
21	CG32-A11	Y219	+5 LED		CN2-15
22	CG32-B11	Y209	+4 LED		CN2-16
23	CG32-A12	Y218	-Y LED		CN2-17
24	CG32-B12	Y208	+Z LED		CN2-18
25	CG32-A13	Y217	越程釋放 LED		CN2-19
26	CG32-B13	Y207	+X LED		CN2-20
27	CG32-A14	Y216	RAPID LED		CN2-21
28	CG32-B14	Y206	-X LED		CN2-22
29	CG32-A15	Y215	-5 LED		CN2-23
30	CG32-B15	Y205	-Z LED		CN2-24
31	CG32-A16	Y214	+Y LED		CN2-25
32	CG32-B16	Y204	-4 LED		CN2-26
33	CG32-A17	Y213	主軸減速 - LED		CN2-27
34	CG32-B17	Y203	主軸 100% LED		CN2-28
35	CG32-A18	Y212	主軸加速 + LED		CN2-29
36	CG32-B18	Y202	主軸正轉 LED		CN2-30
37	CG32-A19	Y211	主軸停止 LED		CN2-31
38	CG32-B19	Y201	主軸反轉 LED		CN2-32
39	CG32-A20	Y210	程式啟動 LED		CN2-33
40	CG32-B20	Y200	程式停止 LED		CN2-34

MITSUBISHI (NEW PANEL)

No.	Position	I/O Point	Use	No.	PIN-No.
1	CG34-A1	×	0V		CN2-62
2	CG34-B1	×	24V3		CN2-1,2
3	CG34-A2	×	0V		CN2-62
4	CG34-B2	×	24V3		CN2-1,2
5	CG34-A3	×	24V3		CN2-1,2
6	CG34-B3	×	24V3		CN2-1,2
7	CG34-A4	×	24V3		CN2-1,2
8	CG34-B4	×	24V3		CN2-1,2
9	CG34-A5	Y23F	工作燈 LED		CN2-35
10	CG34-B5	Y22F	加工吹氣 LED		CN2-36
11	CG34-A6	Y23E	門鎖釋放 LED		CN2-37
12	CG34-B6	Y22E	刀盤正轉 LED		CN2-38
13	CG34-A7	Y23D	排屑正轉 LED		CN2-39
14	CG34-B7	Y22D	切銷液 A LED		CN2-40
15	CG34-A8	Y23C	F1 LED		CN2-41
16	CG34-B8	Y22C	F2 LED		CN2-42
17	CG34-A9	Y23B	F3 LED		CN2-43
18	CG34-B9	Y22B	刀盤反轉 LED		CN2-44
19	CG34-A10	Y23A	排屑反轉 LED		CN2-45
20	CG34-B10	Y22A	切銷液 B LED		CN2-46
21	CG34-A11	Y239	手輪 LED		CN2-61
22	CG34-B11	Y229	切削液異常 LED		CN4-1
23	CG34-A12	Y238	潤滑油異常 LED		CN4-2
24	CG34-B12	Y228	緊急停止 LED		CN4-3
25	CG34-A13	Y237	風壓異常 LED		CN4-4
26	CG34-B13	Y227	油壓異常 LED		CN4-5
27	CG34-A14	Y236	X 軸原點 LED		CN4-6
28	CG34-B14	Y226	Y 軸原點 LED		CN4-7
29	CG34-A15	Y235	Z 軸原點 LED		CN4-8
30	CG34-B15	Y225	第 4 軸原點 LED		CN4-9
31	CG34-A16	Y234	第 5 軸原點 LED		CN4-10
32	CG34-B16	Y224	準備完成 LED		CN4-11
33	CG34-A17	Y233			
34	CG34-B17	Y223			
35	CG34-A18	Y232			
36	CG34-B18	Y222			
37	CG34-A19	Y231			
38	CG34-B19	Y221			
39	CG34-A20	Y230			
40	CG34-B20	Y220			